

Panasonic

Telephone Answering System
with Facsimile

Model No. **KX-F160**

Operating Instructions



Please read these Operating Instructions before using the product.

FOR ASSISTANCE, CALL 1-800-HELP-FAX

*Thank you for purchasing the Panasonic Telephone Answering System with Facsimile.
Before using the unit, please read these Operating Instructions completely.
You can then easily install, configure and operate the unit properly.
This unit combines multiple functions of Facsimile, Answering Device and Telephone;
you can send and receive voice-messages and documents on a single line.*

WARNING:

TO PREVENT FIRE OR SHOCK HAZARD, DO NOT EXPOSE THIS PRODUCT TO RAIN OR ANY TYPE OF MOISTURE.

GETTING HELP FROM YOUR UNIT:

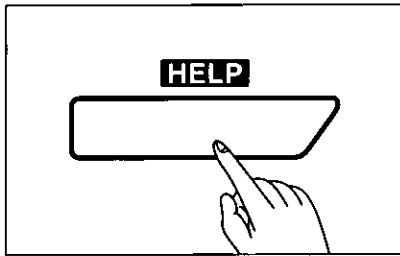

If you press the **HELP** button,
—while programming, the unit will print information about the operation.
—in idle status, the unit will print information about how to send documents, how to set up, etc.

Important information

If required by the telephone company, inform them of the following.

FCC Registration No.: (found on the rear side of the unit)

Ringer Equivalence: 0.5B

The particular telephone line to which the equipment is connected.

This unit must not be connected to a coin operated line. If you are on a party line, check with your local telephone company.

Ringer Equivalence Number (REN):

This REN is useful in determining the quantity of devices you may connect to your telephone line and still have all of those devices ring when your telephone number is called. In most but not all areas, the sum of the REN's of all devices connected to one line should not exceed five (5.0). To be certain of the number of devices you may connect to your line, as determined by the REN, you should contact your local telephone company to determine the maximum REN for your calling area.

In the event that terminal equipment causes harm to the telephone network, the telephone company should notify the customer, if possible, that service may be stopped. However, where prior notice is impractical, the company may temporarily cease service providing that they:

- a) Promptly notify the customer.
- b) Give the customer an opportunity to correct the problem with their equipment.
- c) Inform the customer of the right to bring a complaint to the Federal Communication Commission pursuant to procedures set out in FCC Rules and Regulations Subpart E of Part 68.

The Telephone Company may make changes in its communications facilities, equipment operations, or procedures where such action is reasonably required in the operation of its business and is not inconsistent with the rules and regulations in FCC Part 68. If such changes can be reasonably expected to render any customer terminal equipment incompatible with telephone company communications facilities, or require modification or alteration of such terminal equipment, or otherwise materially affect its use or performance, the customer shall be given adequate notice in writing, to allow the customer an opportunity to maintain uninterrupted service.

CAUTION:

To assure continued compliance with FCC rules, do not make any unauthorized modifications.

When programming emergency numbers and/or making test calls to emergency numbers:

1. Remain on the line and briefly explain to the dispatcher the reason for the call before hanging up.
2. Perform such activities in the off-peak hours; such as early morning or late evenings.

This telephone provides magnetic coupling to hearing aids.

Note:

This equipment has been tested and found to comply with the limits for a Class B digital device, pursuant to Part 15 of the FCC Rules. These limits are designed to provide reasonable protection against harmful interference in a residential installation. This equipment generates, uses, and can radiate radio frequency energy and, if not installed and used in accordance with the instructions, may cause harmful interference to radio communications. However, there is no guarantee that interference will not occur in a particular installation. If this equipment does cause harmful interference to radio or television reception, which can be determined by turning the equipment off and on, the user is encouraged to try to correct the interference by one or more of the following measures:

- Reorient or relocate the receiving antenna.
- Increase the separation between the equipment and receiver.
- Connect the equipment into an outlet on a circuit different from that to which the receiver is connected.
- Consult the dealer or an experienced radio/TV technician for help.

CAUTION

The telephone Consumer Protection Act of 1991 makes it unlawful for any person to use a computer or other electronic device to send any message via a telephone facsimile machine unless such a message clearly contains in a margin on the top or bottom of at least the first sent page the following information:

- 1) Date and time of transmission; and,
- 2) Identification of either business, business entity or individual sending the message; and,
- 3) Telephone number of either the sending machine, business, business entity or individual.

In order to program this information into your facsimile machine, you must complete the steps on pages 1-18 to 1-22 in these Operating Instructions.

Table of Contents

Introduction	viii
Chapter 1 Installation and Initial Preparation	
Location of Controls	1-2
Front view	1-2
Rear view	1-3
Side view	1-3
Buttons and Indicators	1-4
Installing Your Unit	1-7
Precaution	1-7
Accessories	1-8
Installation connections	1-9
Installing the receiving tray and the diverter	1-10
Installing the microcassette tape	1-11
Installing the recording paper	1-12
Setting selectors	1-14
Turning the POWER switch on	1-15
Recording Your Greeting Message	1-16
Suggested message	1-16
Recording a greeting message	1-17
Checking your greeting message	1-17
Programming Your Fax Document Identifiers	1-18
Setting date and time	1-18
Setting your logo	1-20
Programming your facsimile telephone number	1-22
Selecting the RECEIVE MODE	1-23
Setting Up Your Facsimile Unit	1-24
System setup features	1-24
How to set up	1-26
Individual transmission report setting	1-27
Selecting the number of rings to answer in the ANS/FAX mode	1-29
Selecting the number of rings to answer in the FAX mode	1-31
Selecting the caller's recording time	1-32
Setting the remote code (REMOTE ANS ID) for remote operation	1-33
HELP Function —If you have lost your procedures—	1-34
Using the HELP button	1-34
Chapter 2 Basic Instructions	
<i>Facsimile and Copier</i>	
Before Transmitting Documents	2-2
Acceptable documents	2-2

Documents you cannot send	2-2
Resolution and contrast	2-3
Loading documents	2-3
Transmitting Documents	2-4
Manual transmission	2-4
Adding extra pages	2-5
Receiving Documents and/or Voice Calls	2-6
Manual reception	2-6
Automatic reception	2-7
Receiving in the ANS/FAX mode	2-7
Receiving in the TEL/FAX mode	2-8
Receiving in the FAX mode	2-8
Making a Copy	2-9
<i>Answering Device</i>	
Operating as an Answering Device	2-10
Setup of voice message and document reception	2-11
Listening to newly recorded messages	2-11
Listening to all the recorded messages	2-12
Recording after the messages you want to save	2-12
Monitoring incoming calls	2-13
Recording a memo message	2-13
Recording a telephone conversation (2-way recording)	2-14
<i>Telephone</i>	
Making and Answering Voice Calls	2-15
Making voice calls	2-15
Redialing the last dialed number	2-16
Answering voice calls	2-16
Chapter 3 Intermediate Instructions	
Storing Phone Numbers for Automatic Dialing	3-2
Listing the directory card	3-2
Storing phone numbers for one touch dialing	3-3
Storing phone numbers for speed dialing	3-4
Storing secret phone numbers	3-5
Erasing a stored phone number	3-6
<i>Facsimile</i>	
Transmitting Documents Using Automatic Dialer	3-7
<i>Telephone</i>	
Making Voice Calls Using Automatic Dialer	3-8

Chapter 4 Advanced Instructions

Facsimile and Copier

Polling	4-2
Polling another unit manually	4-2
Polling another unit using automatic dialer	4-3
Setting the polling password	4-4
Network Communication	4-5
Using a passcode	4-6
Programming the main passcode	4-7
Turning the TX passcode check on	4-8
Turning the RX passcode check on	4-9
Remote Fax Receiving Using an Extension Phone	4-10
Using an extension phone	4-10
Programming a remote fax activation code	4-11
Setting the Logo Print Position	4-12
Setting a Customized Header	4-13

Answering Device

Operating an Answering Device from a Remote Phone	4-15
Summary of remote control functions	4-15
Playing back newly recorded messages (Memory playback)	4-16
Playing back all messages	4-16
Back space and skip forward	4-17
Recording a marker message	4-17
Resetting the tape for future messages	4-18
Room monitor	4-19
Skipping the greeting message for incoming message recording mode	4-19
Re-recording a greeting message	4-20
Call with Privacy Ring	4-21
Calling with the privacy ring	4-21
Programming the PRIVACY RING ID	4-22
Setting the Message Alert	4-23

Telephone

Voice Contact	4-24
Initiating voice contact	4-24
Receiving a request for voice contact	4-24
TONE, FLASH and PAUSE Button Usage	4-25
TONE button (Temporary tone dialing)	4-25
FLASH button	4-25
PAUSE button	4-26
Combination dialing	4-26

Other Features	4-27
Setting Day/Night Mode	4-27
Setting the Silent Fax Recognition Ring	4-29
Resetting the setup features	4-30

Chapter 5 Printing Reports and Lists

Activity Report (JOURNAL Report)	5-2
Setting the JOURNAL AUTO PRINT	5-3
Printing a JOURNAL report manually	5-4
List of Stored Phone Numbers (TELEPHONE NUMBER LIST)	5-5
Printing a TELEPHONE NUMBER LIST	5-6
Basic Feature List	5-7
Advanced Feature List	5-8

Chapter 6 General Information

Troubleshooting	6-2
General corrective measures	6-2
Clearing a document jam	6-5
Clearing a recording paper jam	6-6
Maintenance	6-8
Cleaning the microcassette compartment	6-8
Cleaning the document feeder unit	6-9
Cleaning the thermal head	6-9
Printing a test pattern	6-10
Accessory Order Information	6-11
Specifications	6-11
Index	6-12

Introduction

Multi-function system using one telephone line

General

- Desktop type
- Automatic paper cutter
- Paper Curl Reduction Technology
- Automatic voice/facsimile switching
- Silent ring fax recognition system
- Copier function
- Help function

Facsimile

- 17-second transmission speed*
- Sends/receives 216 mm (8½")×600 mm (23⅝") pages at CCITT G3
- Automatic document feeder (up to 10 pages)
- One-touch sending buttons
- 16-level halftones
- Resolution: standard/fine/super fine/halftone
- Network passcode communication
- Polling function

*Transmission times apply to text data using CCITT No. 1 test chart, between same machine models at maximum modem speed. Transmission times vary in actual usage.

Answering Device

- Recordable greeting message chip
- Auto-Logic operation for one-touch message playback
The unit automatically plays back all recorded messages or the new messages at the touch of the ALL MESSAGES or the NEW MESSAGES button and stops at the end of the last message, then resets to answer and record the next call.
- Remote control from touch tone telephone
- Message memo recording
- New message playback

Integrated Telephone System

- 12-station one-touch dialer
- 10-station speed dialer
- One-touch redial
- Call monitor for on-hook dialing

Four types of receiving modes

ANS/FAX mode:

When you wish to use the unit as a telephone answering device and a facsimile, or when your machine is unattended, select this mode. When a call is received during your absence, the unit records a voice-message and/or receives a document automatically depending on the caller's choice. In this mode, you also are able to speak with the other party and transmit/receive a document manually when in your office. The unit automatically distinguishes between voice and fax calls.

- a) If the unit detects a fax tone while playing the greeting message, it will automatically activate the fax function.
- b) If the calling party presses the asterisk (*) key while playing the greeting message or incoming message recording mode, it will automatically activate the fax function.
- c) If the caller's voice is heard within 5 seconds after the beep of the end of the greeting message, the unit will function as an answering device. When the unit does not hear a voice within 5 seconds, the fax function is activated.

TEL/FAX mode:

When in the office, you may select this mode. The unit will automatically distinguish between a telephone call and a fax call.

- a) When the unit receives a fax call, it will automatically activate the fax function and initiate fax reception.
- b) When the unit receives a telephone call, it will ring several times until you pick up the handset. If you do not pick up the handset, the unit will switch automatically to the fax mode.

FAX mode:

When you wish to use the unit as a facsimile machine only, select this mode.

If someone calls you when your unit is in the FAX mode, a fax tone sounds and the person cannot talk to you. Please inform your callers that this is a fax only telephone number.

When in the FAX mode, you may still use the fax telephone to place outgoing voice calls.

TEL (Telephone) mode:

When you wish to use the unit as a standard telephone, select this mode. If you wish to receive an incoming fax during a telephone conversation, press the START button.

Chapter 1

Installation and Initial Preparation

Table of contents

Location of Controls	1-2	Programming Your Fax Document	
Front view	1-2	Identifiers	1-18
Rear view	1-3	Setting date and time	1-18
Side view	1-3	Setting your logo	1-20
Buttons and Indicators	1-4	Programming your facsimile telephone number	1-22
Installing Your Unit	1-7	Selecting the RECEIVE MODE	1-23
Precaution	1-7	Setting Up Your Facsimile Unit	1-24
Accessories	1-8	System setup features	1-24
Installation connections	1-9	How to set up	1-26
Installing the receiving tray and the diverter	1-10	Individual transmission report setting	1-27
Installing the microcassette tape	1-11	Selecting the number of rings to answer in the ANS/FAX mode	1-29
Installing the recording paper	1-12	Selecting the number of rings to answer in the FAX mode	1-31
Setting selectors	1-14	Selecting the caller's recording time	1-32
Turning the POWER switch on	1-15	Setting the remote code (REMOTE ANS ID) for remote operation	1-33
Recording Your Greeting Message	1-16	HELP Function	
Suggested message	1-16	—If you have lost your procedures—	1-34
Recording a greeting message	1-17	Using the HELP button	1-34
Checking your greeting message	1-17		

Location of Controls

Front view

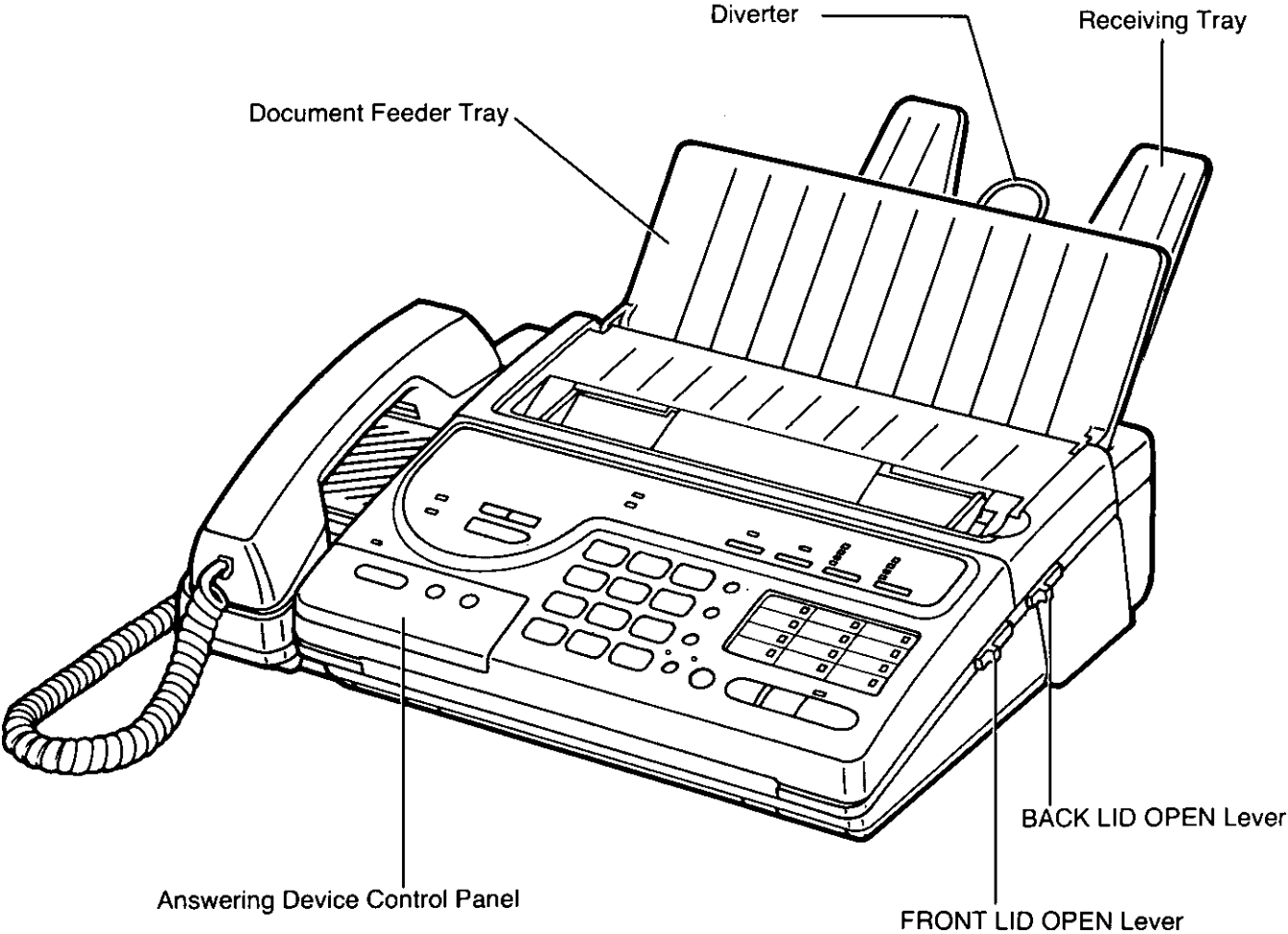

Rear view

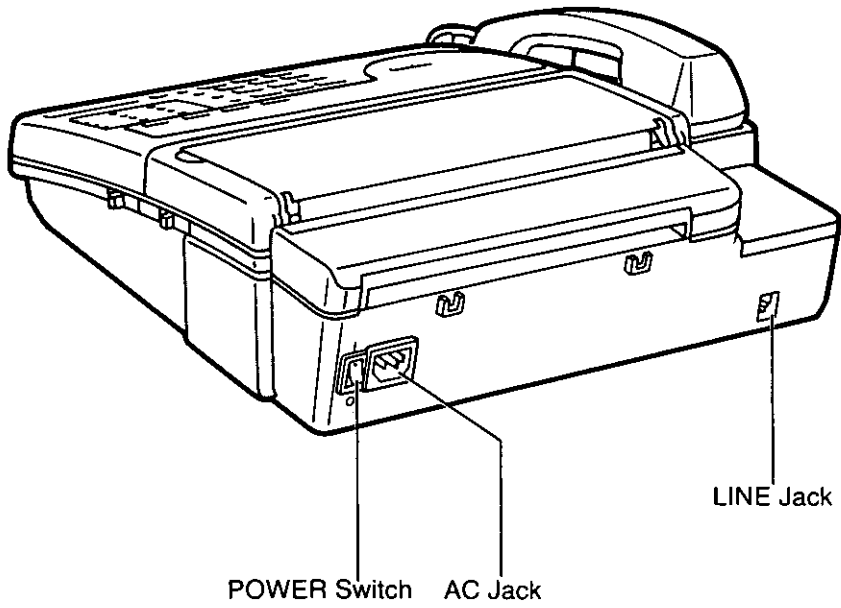

Side view

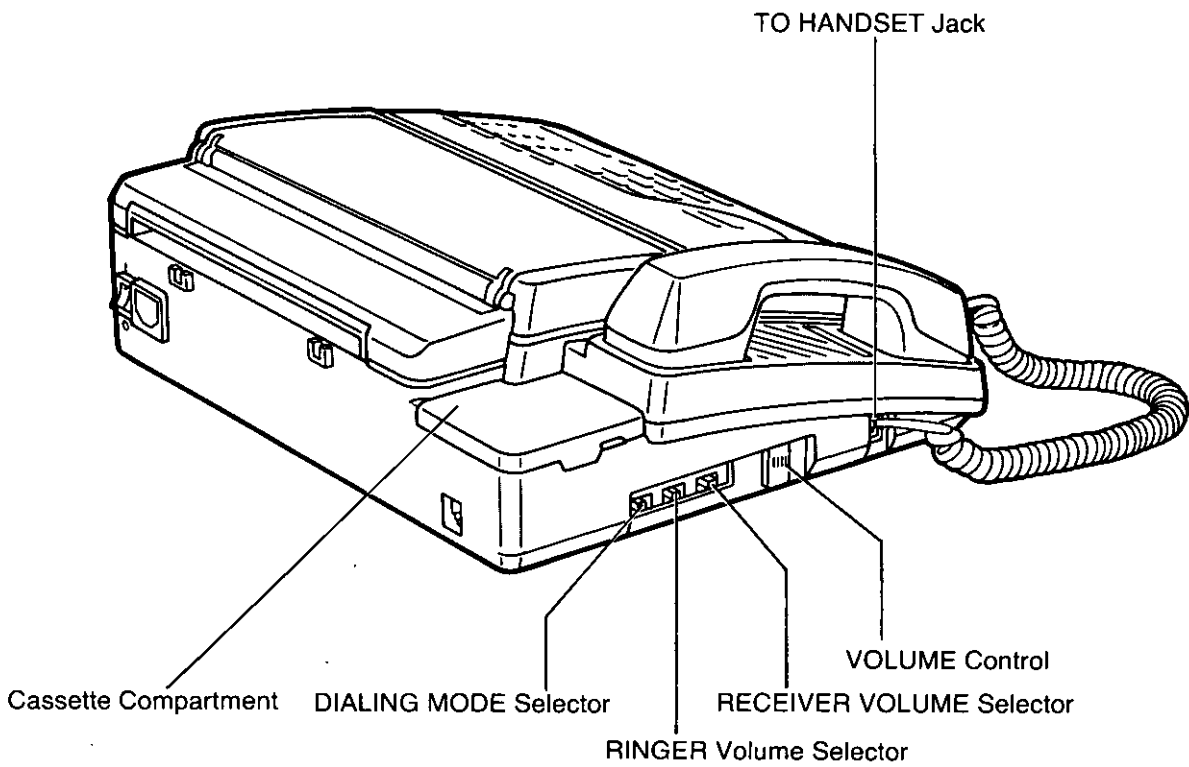

Buttons and Indicators

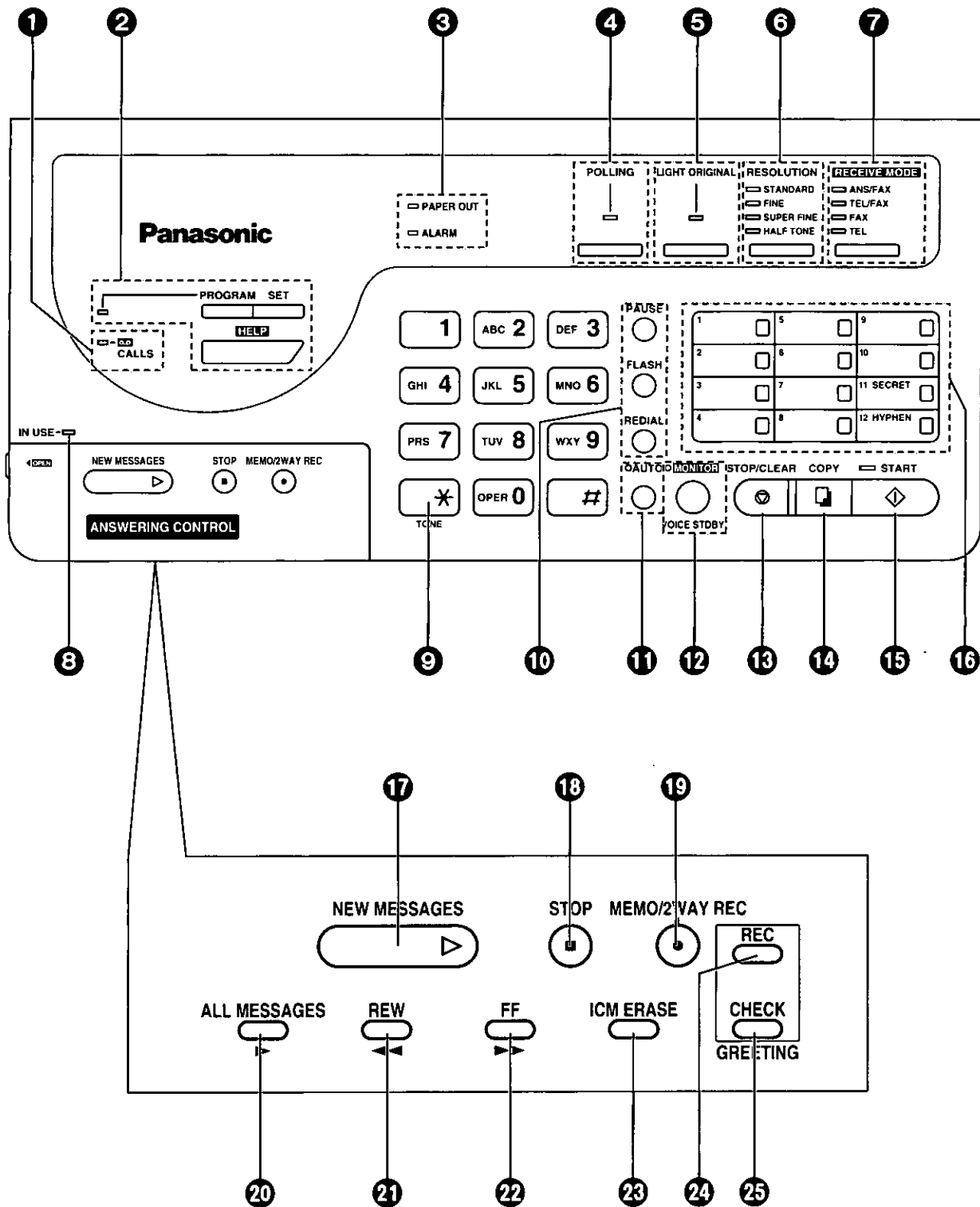

- 1 CALLS Indicator:**
Page 2-10

The indicator flashes to show the number of incoming messages recorded.
- 2 PROGRAM Button and Indicator:**
Page 1-26

Used to start or end programming functions. The indicator lights when this feature is on.
- SET Button:**
Page 1-26

Used to store parameters during programming.
- HELP Button:**
Pages 1-26 and 1-34

Used to print an easy guide of programming procedures.
- 3 PAPER OUT Indicator:**
Page 1-13

The indicator lights when the recording paper roll is empty.
- ALARM Indicator:**
Page 1-15

The indicator lights when any trouble occurs.
- 4 POLLING Button and Indicator:**
Page 4-2

Used for polling function. The indicator lights when this feature is on.
- 5 LIGHT ORIGINAL Button and Indicator:**
Page 2-3

Used to transmit or copy originals with faint writing. The indicator lights when this feature is on.
- 6 RESOLUTION Button and Indicators:**
Page 2-3

Used to adjust scanning line density. The indicators light to show which setting you are using.
- 7 RECEIVE MODE Button and Indicators:**
Pages 1-23 and 2-7

Used to select the desired receiving mode. The indicators light to show the mode in which the unit is set.
- 8 IN USE Indicator:**
Page 2-10

The indicator lights or flashes when the answering device is in use.
- 9 TONE Button:**
Page 4-25

Used to change the dialing mode from pulse to tone during a dialing operation.
- 10 PAUSE Button:**
Page 4-26

Used to insert a pause into a phone number during programming.
- FLASH Button:**
Page 4-25

Used to access some features of your host PBX.
- REDIAL Button:**
Page 2-16

Used to redial the last dialed number.
- 11 AUTO Button and Indicator:**
Pages 3-4 to 3-8

Used for speed dialing. The indicator lights when this feature is on.
- 12 MONITOR (VOICE STDBY) Button and Indicator:**
Pages 2-4, 2-15 and 4-24

Used for on-hook dialing and voice contact features. The indicator lights when these functions are on.

- | | |
|---|--|
| 13 STOP/CLEAR Button:
Pages 1-26, 2-4 to 2-6 | Used to cancel transmission or copying operation. Also used during programming to clear the previously entered parameters. |
| 14 COPY Button:
Page 2-9 | Used to start copy functions. |
| 15 START Button and Indicator:
Pages 1-26 and 2-4 | Used to start transmission or print lists and reports. The indicator lights when these functions are on. |
| 16 Direct Call Station Keys:
Pages 3-2, 3-3 and 3-7 | Used for one touch dialing. |
| 17 NEW MESSAGES Button:
Page 2-11 | Used to play back only new messages. |
| 18 STOP Button:
Page 2-10 | Used to stop operations of answering device. |
| 19 MEMO/2WAY REC Button:
Pages 2-13 and 2-14 | Used to start and stop recording of a memo message or a telephone conversation. |
| 20 ALL MESSAGES Button:
Page 2-12 | Used to play back all the recorded messages. |
| 21 REW (Rewind) Button:
Pages 2-10 and 2-11 | Used to run the tape quickly backward to a desired point. |
| 22 FF (Fast Forward) Button:
Page 2-10 | Used to run the tape quickly forward to a desired point. |
| 23 ICM ERASE Button:
Page 2-10 | Used to erase recorded incoming messages at high speed. |
| 24 REC Button:
Page 1-17 | Used to start and stop recording of a greeting message. |
| 25 CHECK Button:
Page 1-17 | Used to replay your greeting message. |

Installing Your Unit

Precaution

Keep the unit away from heating appliances such as radiators or air conditioning units.

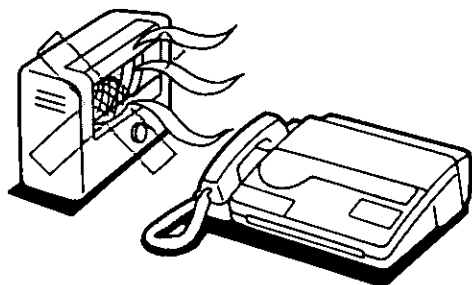

Keep the unit away from electrical noise generating devices such as fluorescent lamps and motors.

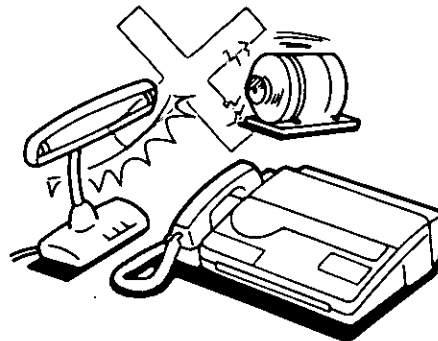

The unit and the cassette tape should not be exposed to direct sunlight.

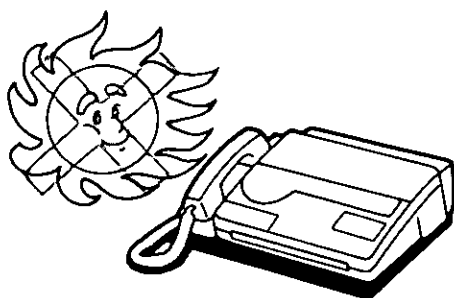

The unit and the cassette tape should be kept free from dust, moisture, high temperature and vibration.

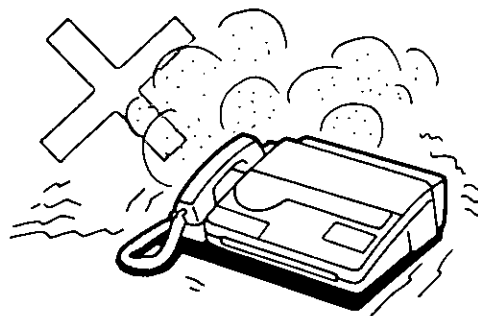

Do not use benzene, thinner, or the like, or any abrasive powder to clean the cabinet. Wipe it with a soft cloth.

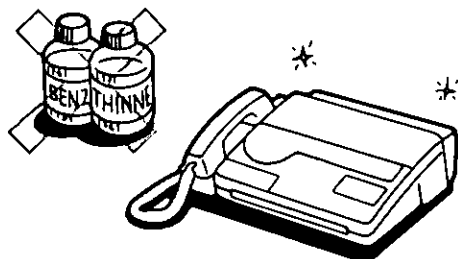

Do not place any covering over the unit while it is turned on.

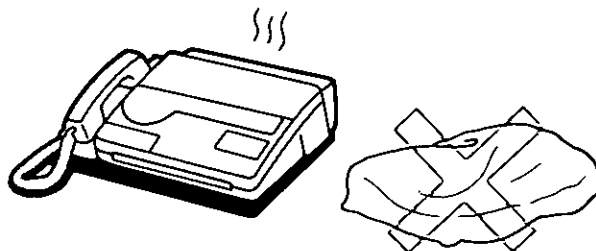

Accessories

1. Carefully remove the unit from the packing carton.
2. Examine the unit for signs of shipping damage.
3. Check that all of the enclosures are included. If you are missing any item, consult your place of purchase.

Telephone Line Cord 1

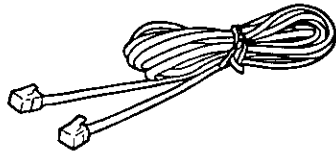

AC Power Cord 1

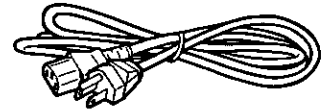

Microcassette Tape 1

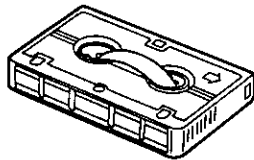

Recording Paper 1

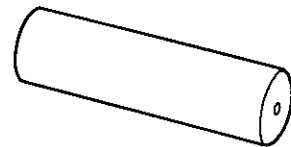

Handset 1

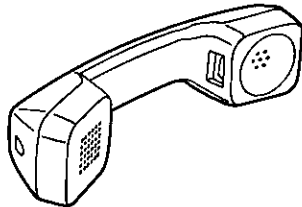

Handset Cord 1

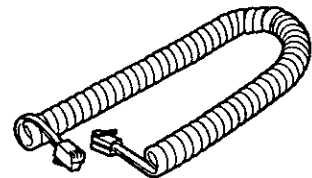

Paper Roll Holders (Green) 2
(For KX-A101 or the recording paper with 1/2 inch core)

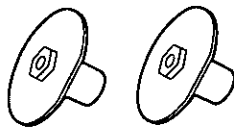

Receiving Tray 1

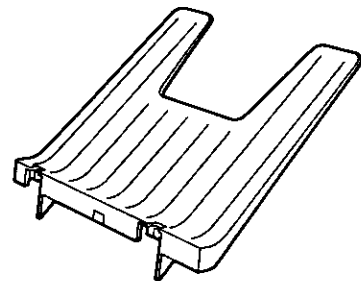

Diverter 1

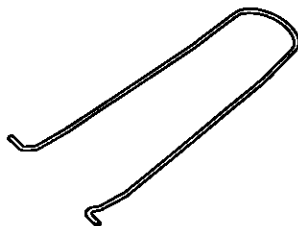

Installation connections

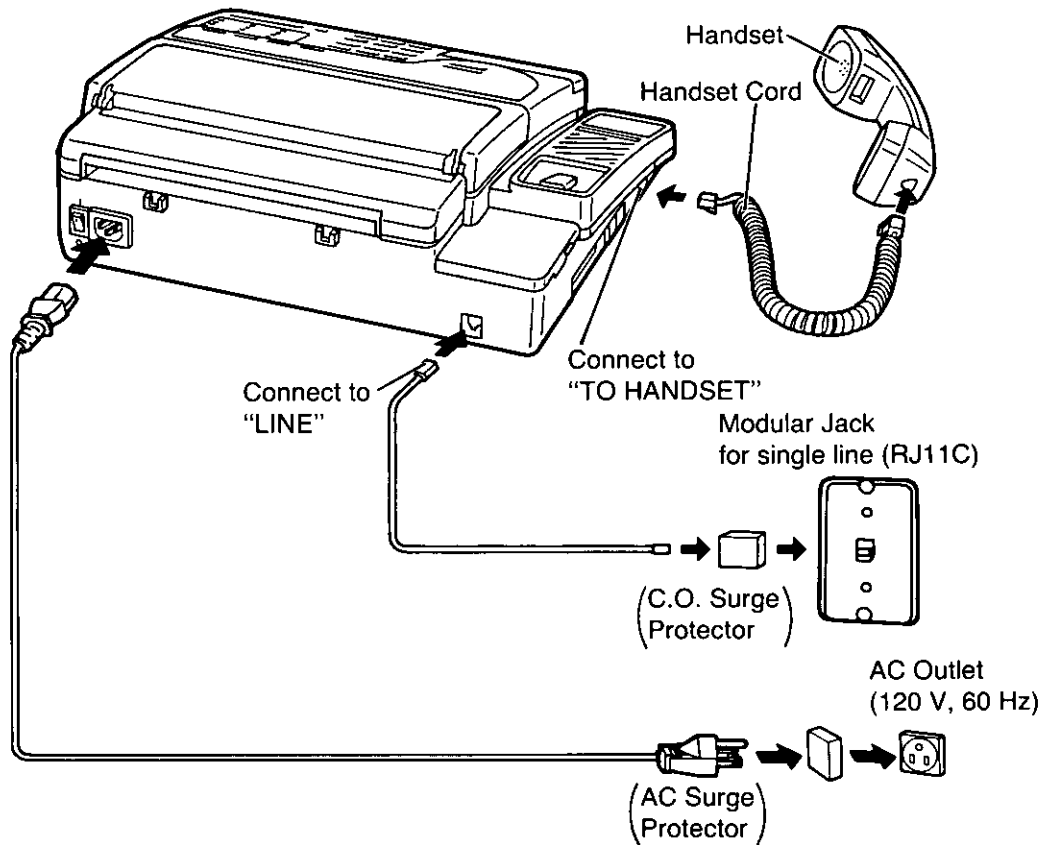

NOTES:

- The unit will not function during a power failure or when the power is turned off.
- Connection to integrated answering machines is not recommended.
- This unit is equipped with a 3-wire grounded type plug for safety. If you are unable to insert the plug into your outlet, contact your electrician to replace your outlet.
- We recommend the use of an exclusive AC outlet to avoid interference from other equipment.
- Place the equipment close to the socket outlet so the socket is easily accessible.
- If your unit is connected to the same line as other extensions, do not use other extensions during fax transmission and reception. Image quality will be affected.
- For additional equipment protection we recommend the use of a surge protector such as TELESPIKE BLOK MODEL TSB (TRIPPE MFG. CO.), SPIKE BLOK MODEL SK6-0 (TRIPPE MFG. CO.), SUPER MAX (PANAMAX) or MP1 (ITW LINX).

Installing the receiving tray and the diverter

To install the receiving tray:

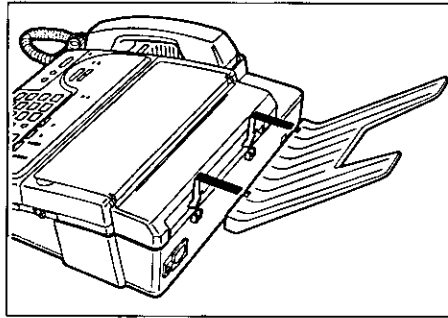

Insert two fins of the tray into holders on the rear side of the unit.

To install the diverter:

The diverter will hold the received documents straight and flat.

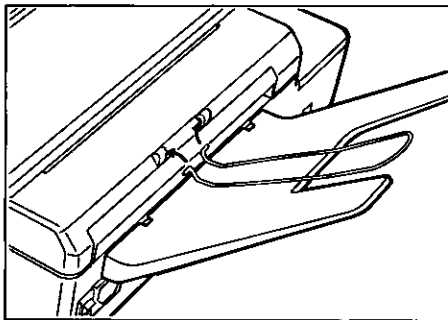

Insert two hooks of the diverter into holders on the rear side of the unit.

Make sure that the diverter is placed in proper direction.

Installing the microcassette tape

The microcassette tape is used to record incoming messages.
To install a microcassette tape:

1

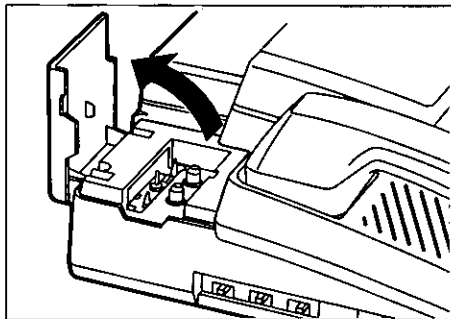

Pull up the cassette compartment cover.

2

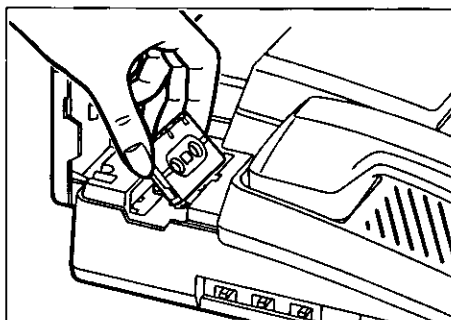

Insert the microcassette tape into the compartment with the full reel to the left. Make sure that there is no slack in the tape. Remove any slack by using a pencil and rotating the tape reel.

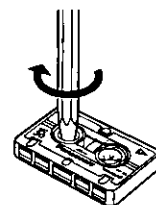

3

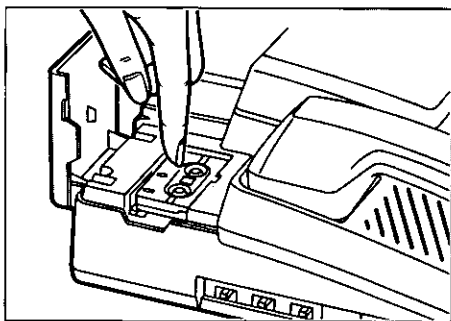

Push the microcassette tape down. Then close the cassette compartment cover.

To take off the microcassette tape:

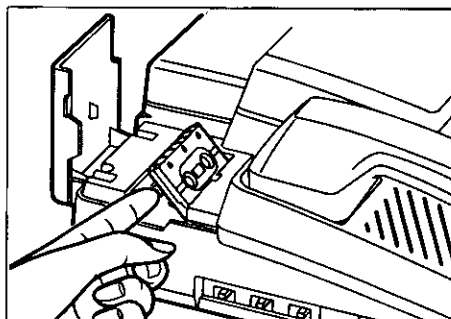

Lift the microcassette tape as shown, then take it off.

NOTES:

- For optimum sound quality and performance, use the opposite side (side B) after six months and replace the tape with a new one every year, assuming that the unit answers about ten calls a day.
- Never place a cassette tape near a magnetic source such as a magnet or a TV set. It may erase or interfere with any messages on the tape.
- Should the cassette tape break or become worn, replace it with a new one. We recommend using the Panasonic cassette tape **MC-30** or **MC-60**.

Installing the recording paper

To install a new roll of recording paper:

1

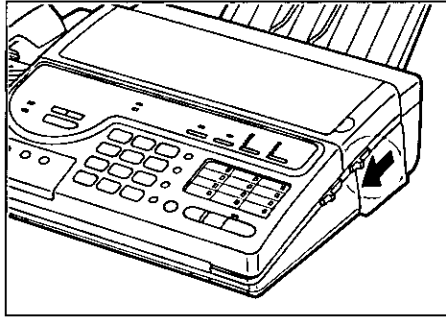

Slide the **BACK LID OPEN** lever forward to open the paper compartment cover.

2

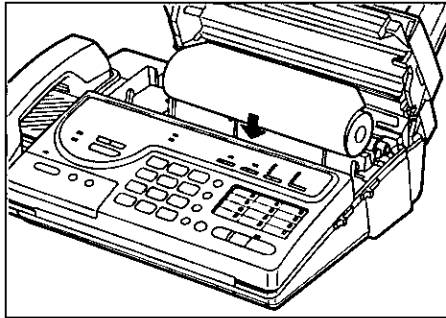

Place a recording paper roll into the paper compartment.

Make sure that the shiny side of the paper is facing up and that there is no slack in the paper roll.

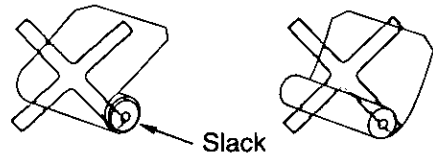

3

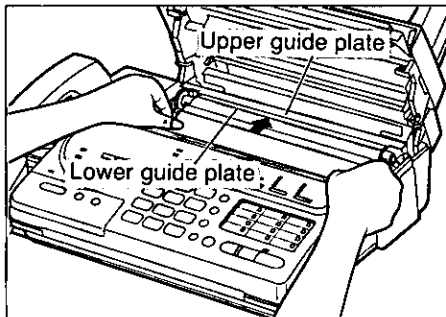

Insert the leading edge of recording paper between the upper and the lower guide plates.

4



Pull the paper a few centimeters (one or two inches) out of the unit.

5

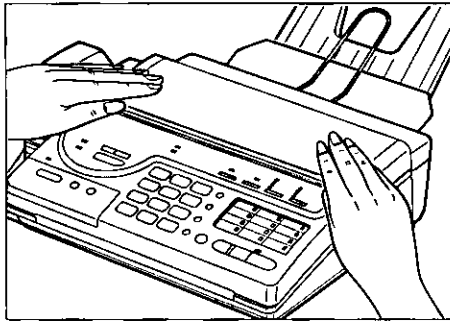

Close the paper compartment cover carefully by pressing down on both ends gently.

When the unit is on, the recording paper will project itself slightly and be cut automatically.

NOTES:

- Use only the included roll or specified recording papers (Part No. KX-A101 and KX-A106) for supplement or else the print quality may be affected or excessive thermal head wear may occur.
- To install the KX-A101 or a recording paper with 1/2 inch core, you should use the included paper roll holders for paper curl reduction system as shown below.

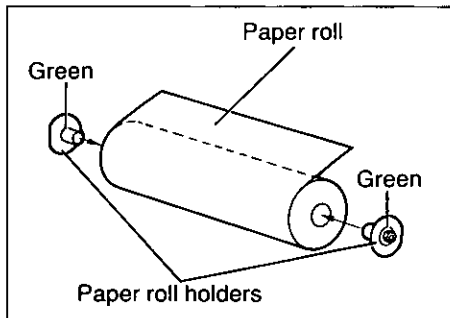

Fix the paper roll holders on both sides of the recording paper roll.

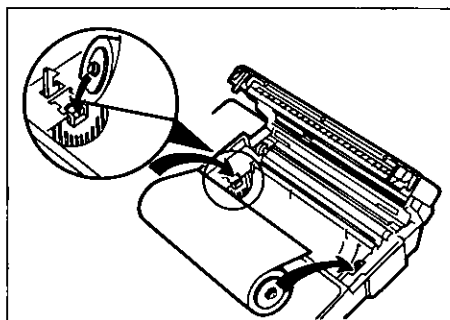

Insert the left projection of the paper roll holder into the left groove on the unit then the right projection into the right groove, while pushing the paper roll to the left.

Follow the procedures from steps 3 to 5 to finish installing a KX-A101 or a recording paper with 1/2 inch core.

- If the recording paper is heavily curled, the paper curl reduction system may not function properly.
- Replace the paper roll with a new one;
 - when the red lines appear on both sides of the recording paper.
 - when the PAPER OUT indicator lights.

Setting selectors

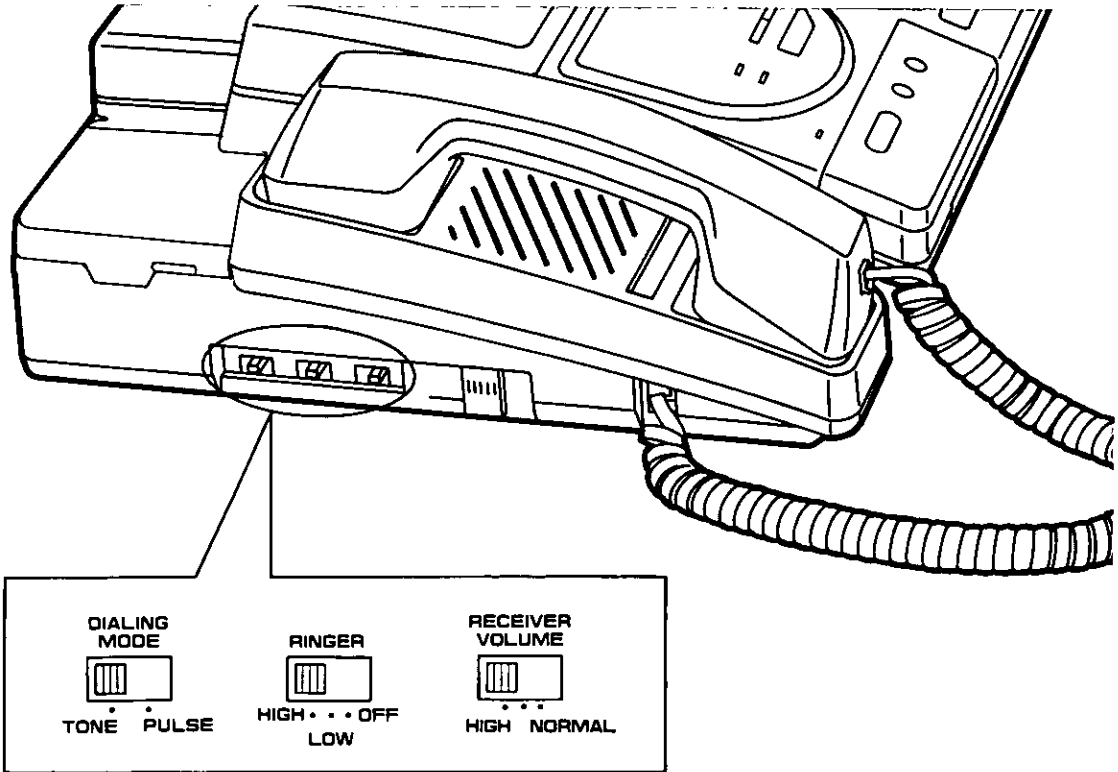

DIALING MODE Selector:

If your line has,

1. Touch tone service, set the selector to **TONE**.
2. Rotary pulse dial service, set the selector to **PULSE**.

RINGER Volume Selector:

HIGH: The ringing sound will be loud.

LOW: The ringing sound will be soft.

OFF: The unit will not ring.

RECEIVER VOLUME Selector:

Adjust the volume level of the handset receiver using the **RECEIVER VOLUME** selector.

The **RECEIVER VOLUME** selector can be moved to 3 positions. The center between **HIGH** and **NORMAL** is the middle level of volume.

When the other party's voice is hard to hear, slide the switch to the center or **HIGH**.

Turning the POWER switch on

Before turning the POWER switch on, confirm the following:

- All connections are completed.
- The cassette tape and the recording paper are installed properly.
- The handset is on the cradle.

1. Turn the **POWER** switch to the "I" (ON) position.

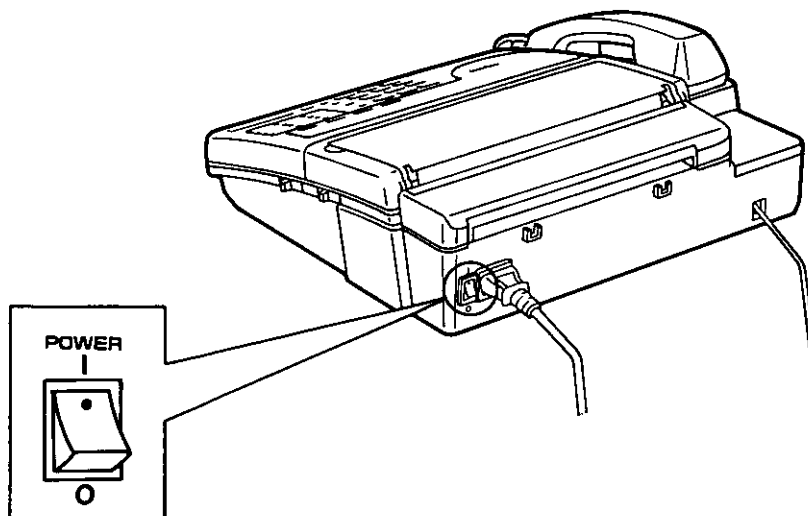

2. When you turn on the unit for the first time, the **ALARM** indicator will light. This shows that the greeting message is not recorded. To record your greeting message, see pages 1-16 and 1-17. If the greeting message is not recorded, you cannot use the unit properly as both an answering device and a facsimile.

NOTES:

- If the **ALARM** indicator still lights, confirm that the covers are closed firmly.
- If the **PAPER OUT** indicator lights, install the recording paper properly (see pages 1-12 and 1-13).

Recording Your Greeting Message

Record a greeting message before using your machine as an answering machine and facsimile.

The greeting message tells the caller that you are unable to answer, and allows him or her to leave a voice-message or to send a fax message.

You can store a greeting message up to 16 seconds.

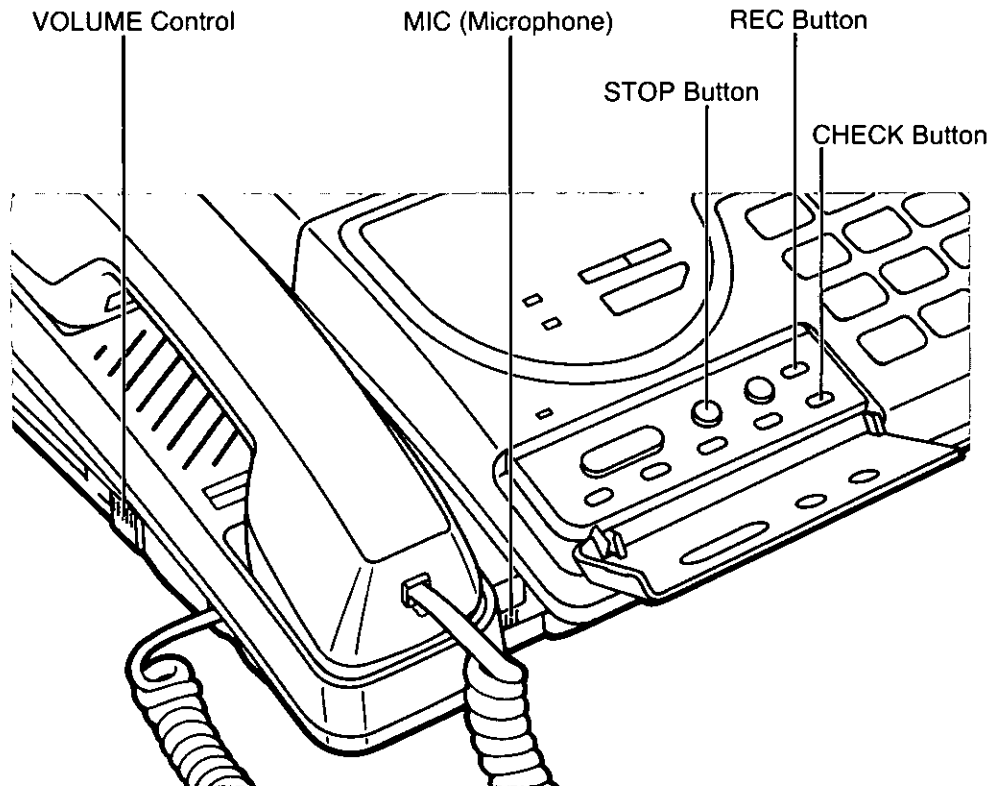

Suggested message

Record your greeting message referring to the examples below.

—When the incoming message recording time is unlimited:

"This is (your name, business and/or telephone number). We are unable to answer right now. To send a fax, start transmission. To leave a message, speak after the long beep. Thank you."

—When the incoming message recording time is limited to 1 minute:

*"This is (your name, business and/or telephone number). We are unable to answer right now. To send a fax, start transmission. To leave a message, speak for **up to 1 minute** after the long beep. Thank you."*

You can choose from two lengths of recording times for incoming messages. When the unit is in the "VOX" position, the recording time is unlimited, and when in the "1 MIN" position, the recording time is limited to 1 minute. The two examples above correspond to these two conditions. The unit is preset to the "VOX" position. To change the recording time, see page 1-32.

Recording a greeting message

Recording time is limited to 16 seconds. Record your greeting message within 12 seconds for optimum performance.

1

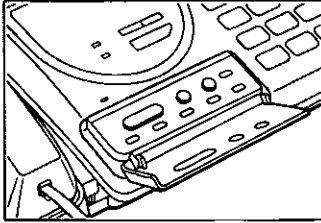

Open the **ANSWERING CONTROL** panel.

2

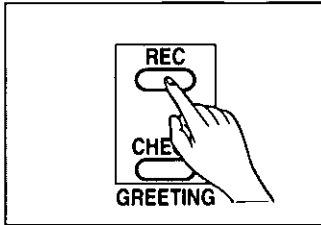

Press the **REC** button.

A beep is heard.

3

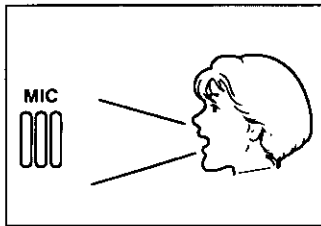

After the beep, speak immediately, clearly and loudly toward the microphone from a distance of approximately 20 cm (8 inches).

4

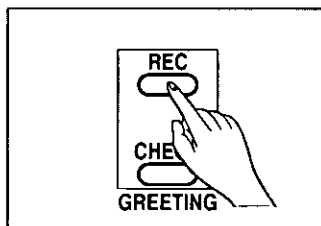

When finished, press the **REC** button again or the **STOP** button.

5

The unit plays back your greeting message so that you can confirm it.

Adjust the **VOLUME** control to a suitable level.

NOTE:

If you make a mistake while recording, repeat from step 2.

Checking your greeting message

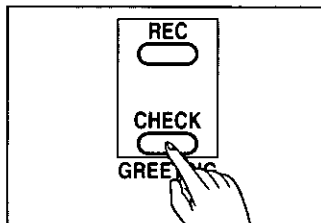

Press the **CHECK** button.

The unit replays your greeting message. If you want to change your message, perform the operation on this page again. The previous message will be automatically erased and a new message will be recorded.

Programming Your Fax Document Identifiers

Your programmed logo and telephone number will be printed on the top of each page transmitted from your unit, along with the date, time and page number.

This gives the receiving party your name and fax telephone number if they wish to return a fax. Before using your unit as a facsimile, you should never fail to set this information.

Sample pages sent by your unit

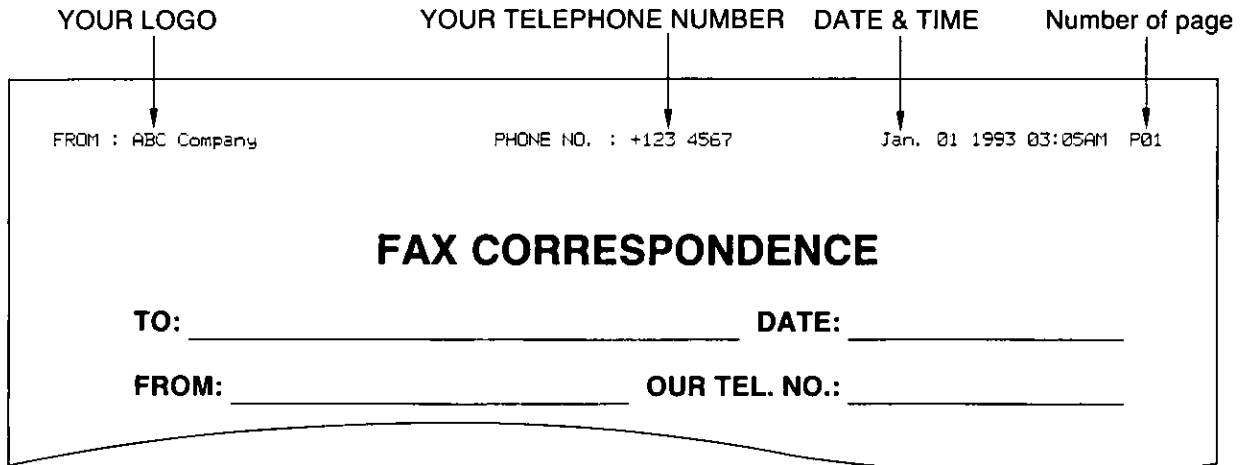

Setting date and time

The internal clock of the unit will print the date and time on the top line of all the documents you transmit and the fax communication reports such as JOURNAL report and transmission report.

HELPFUL HINT:

When you lose your procedures while programming, press the **HELP** button. You will be able to print information about how to set.

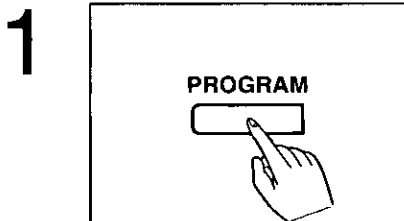

Press the **PROGRAM** button.

The PROGRAM indicator lights.

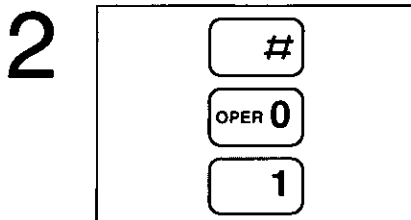

Press #, then press **01** for SET DATE setting.

The PROGRAM indicator flashes.

The current setting is printed out automatically for confirmation.

(continued)

3

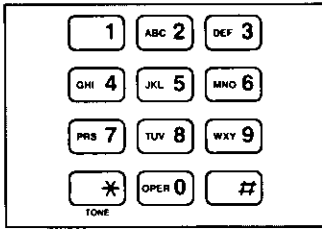

Enter current month/day/year by using the dial keypad.

Example: Aug. 10 1993.

Press 08, 10 then press 1993.

4

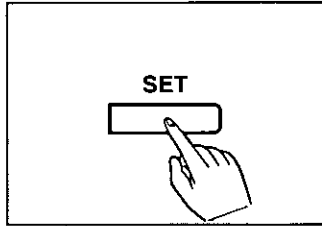

Press the **SET** button.

The result of your setting is printed out automatically for confirmation.

If you wish to correct your programming, press the STOP/CLEAR button then repeat from step 2.

5

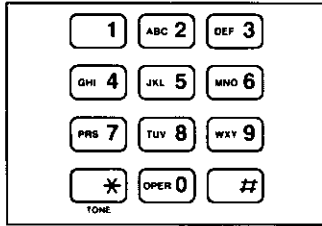

Enter the current time by using the dial keypad.

Example: 3:45 PM

Press 03 then press 45.

Press # to select PM mode.

(To select AM mode, press *.)

6

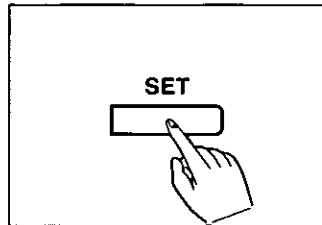

Press the **SET** button to store the program into memory.

The PROGRAM indicator lights.

The result of your setting is printed out automatically for confirmation.

If you wish to correct your programming, repeat from step 2.

7

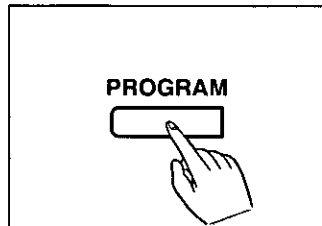

Press the **PROGRAM** button to end the operation.

The PROGRAM indicator goes out.

NOTE:

To correct an error while programming, press the STOP/CLEAR button then repeat from step 2.

Setting your logo

The logo is used to identify fax documents sent by your unit. It may consist of alphanumeric letters and symbols.

Usually the logo is a company, division or personal name in an abbreviated form. Your programmed logo will be printed on the top of each page transmitted from your unit.

Your printed logo can be up to 30 digits long. "Panasonic ANS/FAX" is stored in your unit as default.

To enter each character, select the correct code (2 digits) referring to the character code table (see page 1-21), then program as follows.

HELPFUL HINT:

When you lose your procedures while programming, press the **HELP** button.

You will be able to print information about how to set.

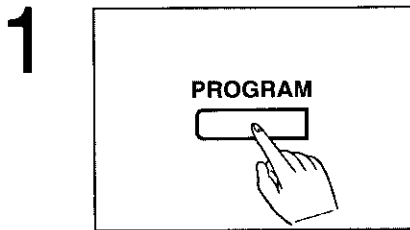

Press the **PROGRAM** button.

The PROGRAM indicator lights.

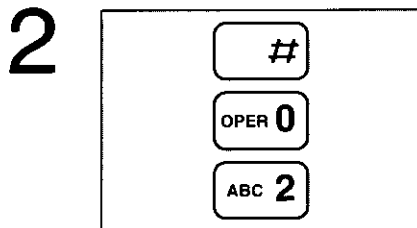

Press #, then press **02**.

The PROGRAM indicator flashes.

To obtain the character codes, press the **HELP** button.

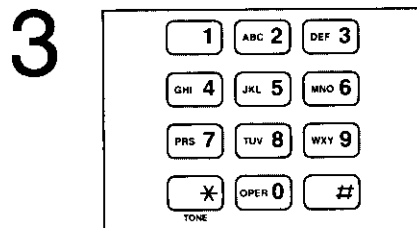

Enter your logo by using the dial keypad.

Example: If you want to program the logo as "ABC Company", press "30 31 32 01 32 74 72 75 60 73 84".

The logo can be up to 30 characters long.

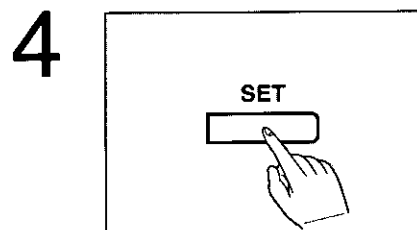

When finished, press the **SET** button to store the program into memory.

The PROGRAM indicator lights.

The result of your setting is printed out automatically for confirmation.

If you wish to correct your programming, try again from step 2.

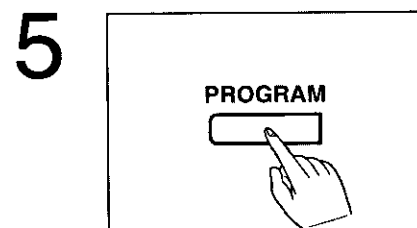

Press the **PROGRAM** button to end the operation.

The PROGRAM indicator goes out.

NOTE:

To correct an error while programming, press the **STOP/CLEAR** button then repeat from step 2.

Programming your facsimile telephone number

Your facsimile telephone number can be programmed into your unit.
 When you transmit a document, your programmed number will be printed on the top of each page transmitted from your unit.
 The unit can hold your phone number up to 20 digits long.

HELPFUL HINT:

When you lose your procedures while programming, press the **HELP** button.
 You will be able to print information about how to set.

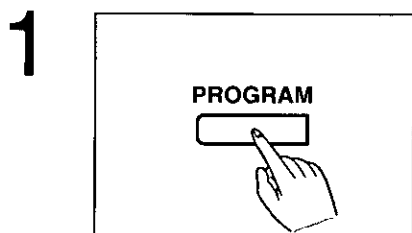

Press the **PROGRAM** button.
 The PROGRAM indicator lights.

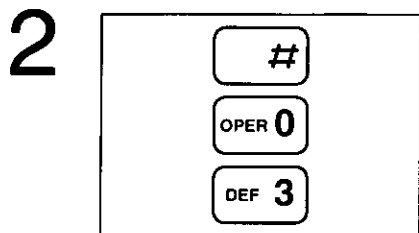

Press #, then press **03**.
 The PROGRAM indicator flashes.

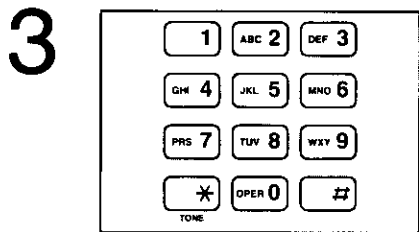

Enter your telephone number by using the dial keypad up to 20 digits long.

Example: If the phone number is +123 4567, press *, 123, #, then press 4567.

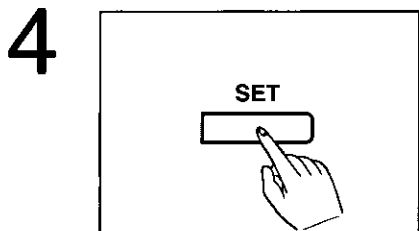

When finished, press the **SET** button to store the program into memory.
 The PROGRAM indicator lights.
 The result of your setting is printed out automatically for confirmation.
 If you wish to correct your programming, try again from step 2.

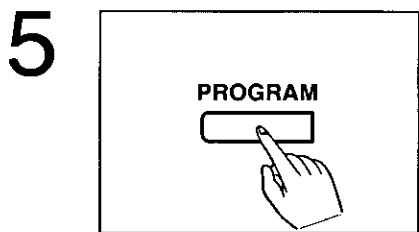

Press the **PROGRAM** button to end the operation.
 The PROGRAM indicator goes out.

NOTE:

The # button provides a space and the * button provides the mark "+".

Selecting the RECEIVE MODE

The unit has four types of receiving modes:

- ANS/FAX mode** —When you want to use as a telephone answering device and a facsimile.
- TEL/FAX mode** —When you want to use telephone and facsimile.
- FAX mode** —When you want to use facsimile only.
- TEL mode** —When you want to use as a standard telephone only.

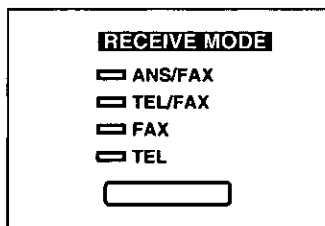

Press the **RECEIVE MODE** button to select the desired receiving mode.

HELPFUL HINTS:

■ When you are out of the office—ANS/FAX mode:

The unit will automatically distinguish between a voice and a fax call. If a fax tone is heard, the unit will automatically activate the fax function. If the caller's voice is heard within 5 seconds of the beep at the end of the greeting message, the answering device will receive messages. You are also able to speak with the other party and transmit or receive documents when in this mode.

■ When you are in the office—TEL/FAX mode:

The unit will automatically distinguish between a normal telephone call and a fax call. When the unit receives an automatic fax transmission call, it will switch automatically to fax function and initiate fax reception. When the unit receives a voice or manual transmission call, it will ring several times until you pick up the handset. —If you do not pick up the handset, the unit will automatically activate the fax function. —When you pick up the handset and nothing is heard, manual fax reception is required. Press the **START** button and hang up to receive the fax.

■ When you wish to use as a facsimile only—FAX mode:

In this mode you will only be able to receive fax calls. Incoming voice calls will hear the fax tone. You are still able to make outgoing voice calls.

■ When you wish to use as a standard telephone—TEL mode:

This mode is for use as a standard telephone. You can also receive a fax during a telephone conversation by pressing the **START** button. In this mode, if you do not answer the call until the unit rings 15 times, the unit will automatically switch to the ANS/FAX mode.

Setting Up Your Facsimile Unit

System setup features

The unit has 9 Basic Features, as listed below, and 16 Advanced Features, as listed on page 1-25.

Basic Features are the settings that need to be programmed upon finishing the installation. Most probable choices have been preselected for you, but some features, such as SET DATE, YOUR LOGO and YOUR TELEPHONE NUMBER, must be programmed by the user.

Advanced Features should be temporarily programmed as the need arises.

Before using your unit as a facsimile, you should never fail to set the following features.

#01 SET DATE (Pages 1-18, 1-19)

#02 YOUR LOGO (Pages 1-20, 1-21)

#03 YOUR TELEPHONE NUMBER (Page 1-22)

BASIC FEATURE LIST

The bold-face indicates factory default settings.

Code	Functions	Descriptions	Selections	Pages
#01	SET DATE	Sets the current date and time	(not stored)	1-18 1-19
#02	YOUR LOGO	Sets your company name or personal name	up to 30 digits	1-20 1-21
#03	YOUR TELEPHONE NUMBER	Sets your facsimile telephone number	up to 20 digits	1-22
#04	PRINT TRANSMISSION REPORT	Individual transmission report setting	ON/ERROR/OFF	1-27 1-28
#05	ANS/FAX RING COUNT	Selects the number of rings to answer in the ANS/FAX mode, or sets RINGER to off	TOLL SAVER or 1 to 4 rings or RINGER OFF	1-29 1-30
#06	FAX RING COUNT	Selects the number of rings to answer in the FAX mode	1 to 4 rings	1-31
#07	RECORDING TIME FOR ANS	Selects the recording time for incoming message	VOX (unlimited) or 1 MIN (1 minute)	1-32
#08	REMOTE ANS ID	Sets the remote control code for remote ANS operation	3 digits (111)	1-33
#99	PRINT ADVANCED FEATURE LIST	Prints the advanced feature list		5-8

ADVANCED FEATURE LIST

The bold-face indicates factory default settings.

Code	Functions	Descriptions	Selections	Pages
#10	LOGO POSITION	Sets the LOGO print position on the transmitted document	OUT/IN/OFF	4-12
#11	JOURNAL AUTO PRINT	Prints out the journal report automatically or manually	AUTO/MANUAL	5-3
#12	MAIN PASSCODE	Sets the passcode for network communication	4 digits (0000)	4-7
#13	TX PASSCODE CHECK	Turns the transmission passcode check mode on	ON/OFF	4-8
#14	RX PASSCODE CHECK	Turns the reception passcode check mode on	ON/OFF	4-9
#15	POLLING PASSWORD	Sets the password for polling	4 digits (0000)	4-4
#17	PRIVACY RING ID	Sets the PRIVACY RING ID	3 digits (333)	4-22
#18	DAY/NIGHT MODE	Turns on the Day/Night Mode	ON/OFF	4-27 4-28
#19	SILENT FAX RECOGNITION RING	Sets the silent fax recognition ring	3 to 8 rings	4-29
#20	REMOTE FAX ACTIVATION CODE	Sets the remote fax activation code	2 to 4 digits (**)	4-11
#22	MESSAGE ALERT	Turns on the message alert	ON/OFF	4-23
#23	CUSTOMIZED HEADER	Sets a customized header	A/B/C/OFF	4-13 4-14
#26	PRINT JOURNAL	Prints a JOURNAL report		5-4
#27	PRINT TEL LIST	Prints a telephone number list		5-5 5-6
#28	PRINTER TEST	Prints a print test pattern		6-10
#50	SET DEFAULT (#10 TO #23)	Resets the setup features		4-30

How to set up

To set up your unit, proceed as follows.

HELPFUL HINT:

If you press the **HELP** button

—while programming, the unit will print information about the operation.

—in idle status, the unit will print information about how to send documents, how to set up, etc.

1. Press the **PROGRAM** button.
The PROGRAM indicator lights.
2. Press #, then enter the code number you wish to set using the dial keypad.
Refer to the lists on pages 1-24 and 1-25.
The PROGRAM indicator flashes.
3. Enter desired choice or data.
4. If you entered “#26”, “#27”, “#28”, “#50” and “#99”, press the **START** button.
Otherwise press the **SET** button to store your selection.
The PROGRAM indicator lights.
5. Press the **PROGRAM** button to end the operation.
The PROGRAM indicator goes out.

NOTES:

- When the code number is “#01”, “#02”, “#03” or “#18”, the result of your setting is printed out automatically after you press the SET button in step 4.
- To correct an error while programming, press the STOP/CLEAR button then repeat from step 2.
- To cancel programming on the way, press the PROGRAM button.

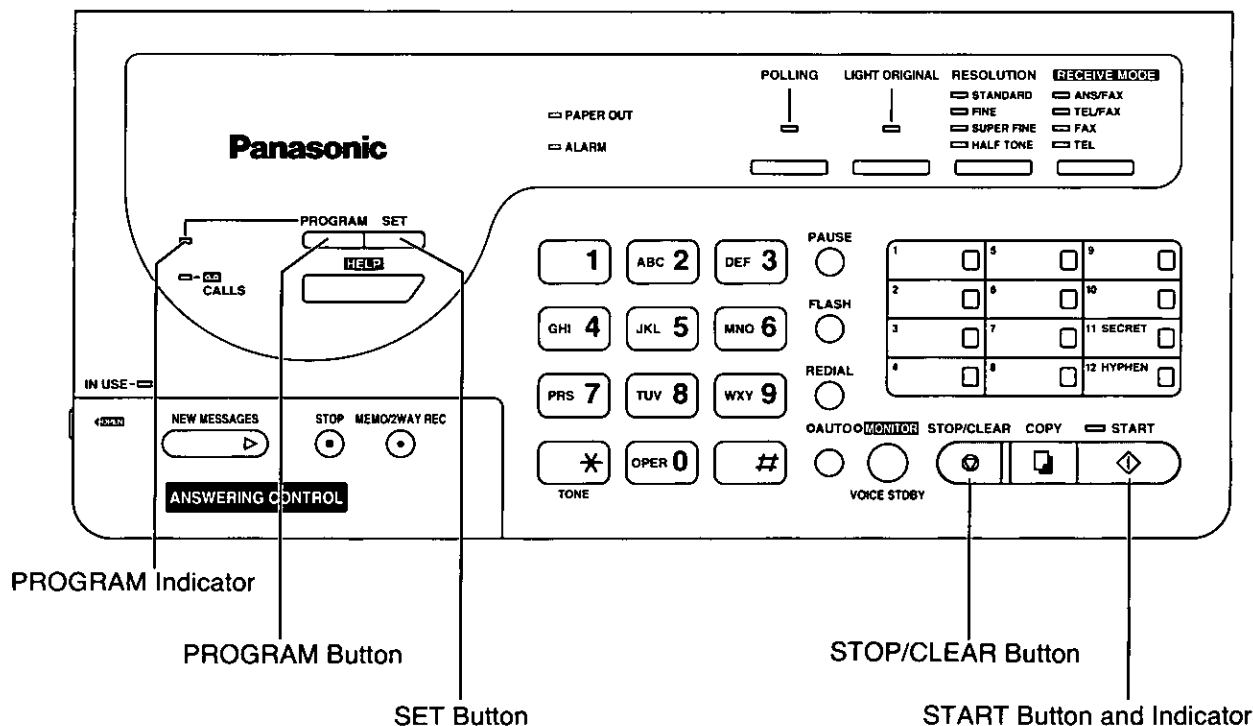

To change the individual transmission report setting, proceed as follows.

HELPFUL HINT:

When you lose your procedures while programming, press the **HELP** button. You will be able to print information about how to set.

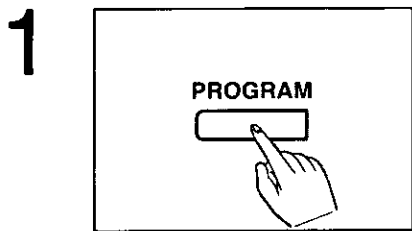

Press the **PROGRAM** button.

The PROGRAM indicator lights.

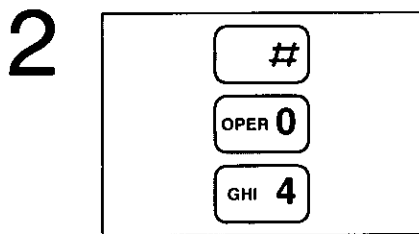

Press #, then press **04**.

The PROGRAM indicator flashes.

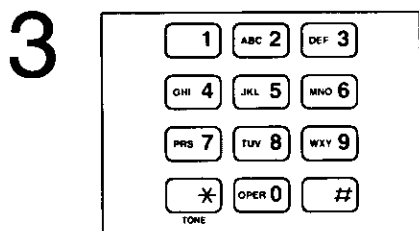

Press the number of the mode you desire.

Setting selections are:

- 1: ON
- 2: ERROR
- 3: OFF

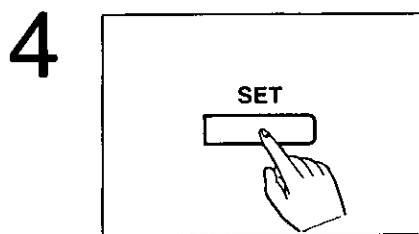

Press the **SET** button to store your selection into memory.

The PROGRAM indicator lights.

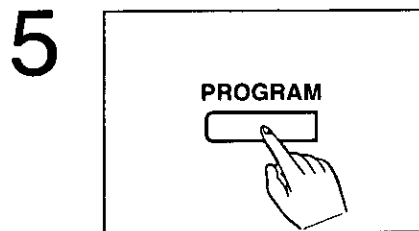

Press the **PROGRAM** button to end the operation.

The PROGRAM indicator goes out.

Selecting the number of rings to answer in the ANS/FAX mode

When in the ANS/FAX mode, the unit will automatically answer on the first ring when receiving a call.

If you wish to change the number of rings to answer a call, you can choose among the following:

- 0: Toll Saver (see page 1-30).
- 1: The unit answers on the first ring (default).
- 2: The unit answers on the second ring.
- 3: The unit answers on the third ring.
- 4: The unit answers on the fourth ring.
- *: The unit will not ring (RINGER OFF).

HELPFUL HINTS:

- When you lose your procedures while programming, press the **HELP** button. You will be able to print information about how to set.
- If you wish to have the opportunity to pick up the handset before the call is answered by the unit, set the number of rings to "3" or "4".
- If you find there is difficulty in fax receiving from machines that have an automatic transmission feature, set the number of rings to "1".
- To confirm from the remote phone whether a new incoming message has been recorded or not (see pages 4-15 to 4-20), select the Toll Saver position. This will save you the toll charge for the call.

1

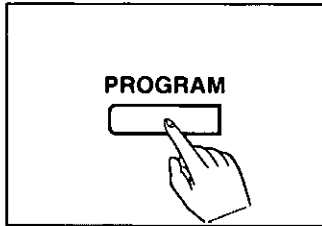

Press the **PROGRAM** button.

The PROGRAM indicator lights.

2

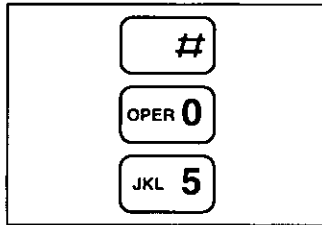

Press #, then press **05**.

The PROGRAM indicator flashes.

3

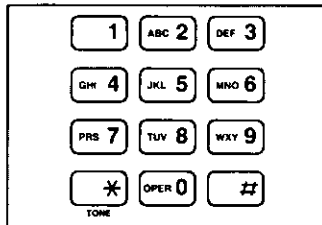

Press the number of the selection you desire.

Setting selections are:

- 0: Toll Saver
- 1: one ring
- 2: two rings
- 3: three rings
- 4: four rings
- *: Ringer Off

4

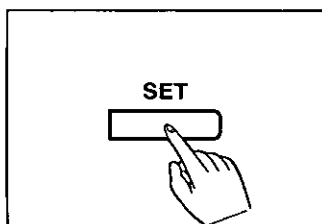

Press the **SET** button to store your selection into memory.

The PROGRAM indicator lights.

5

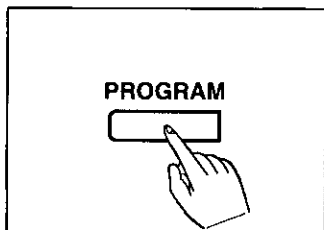

Press the **PROGRAM** button to end the operation.

The **PROGRAM** indicator goes out.

Toll Saver:

When you call the unit from a remote location, the number of rings tells you if there are any new voice-messages.

If the unit answers on the first ring, there is at least one new message recorded.

If the unit answers on the third ring, there are no new messages recorded.

Hang up immediately when you hear the second ring. The second ring indicates that there are no new messages. This will save you the toll charge for the call.

NOTE:

If you set the RINGER OFF through the ANS/FAX RING COUNT function, the extension phone connected to the unit will ring once when receiving a call.

Selecting the number of rings to answer in the FAX mode

When in the FAX mode, the unit will automatically answer on the first ring when receiving a call. If you wish to change the number of rings to answer a call, you can choose the number among "1" (one ring) through "4" (four rings).

HELPFUL HINTS:

- When you lose your procedures while programming, press the **HELP** button. You will be able to print information about how to set.
- If you wish to have the opportunity to pick up the handset before the call is answered by the unit, set the number of rings to "3" or "4".
- If you find there is difficulty in fax receiving from machines that have an automatic transmission feature, set the number of rings to "1".

1

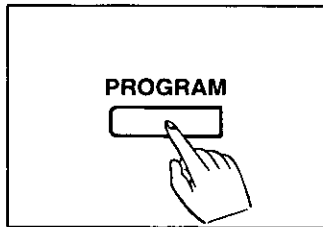

Press the **PROGRAM** button.

The PROGRAM indicator lights.

2

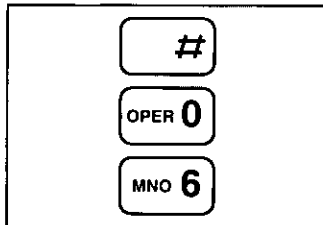

Press #, then press **06**.

The PROGRAM indicator flashes.

3

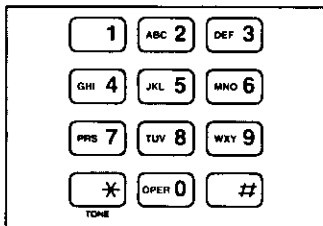

Press the number of the selection you desire.

Setting selections are:

- 1: one ring
- 2: two rings
- 3: three rings
- 4: four rings

4

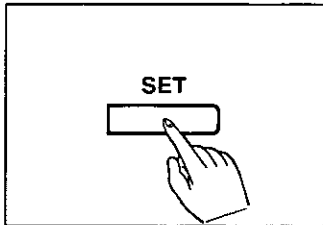

Press the **SET** button to store your selection into memory.

The PROGRAM indicator lights.

5

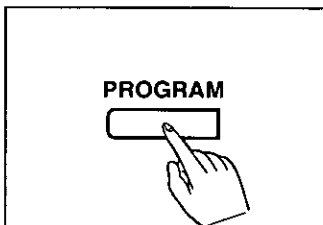

Press the **PROGRAM** button to end the operation.

The PROGRAM indicator goes out.

Selecting the caller's recording time

You can choose from two lengths of recording times for incoming messages.

VOX: The unit records an incoming message as long as a caller speaks (default).

1 MIN: The unit records an incoming message up to 1 minute per message.

To change the recording time, proceed as follows:

HELPFUL HINT:

When you lose your procedures while programming, press the **HELP** button.

You will be able to print information about how to set.

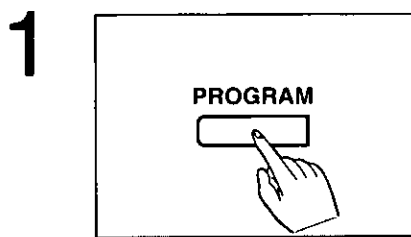

Press the **PROGRAM** button.

The **PROGRAM** indicator lights.

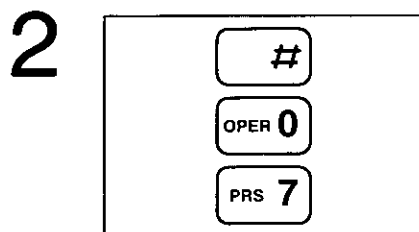

Press #, then press **07**.

The **PROGRAM** indicator flashes.

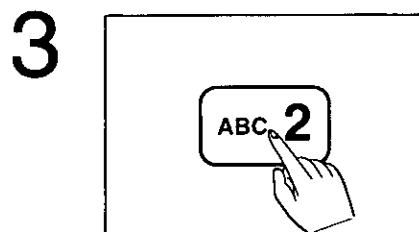

Press **2** by using the dial keypad.

Setting selections are:

1: **VOX** (unlimited)

2: **1 MIN** (1 minute)

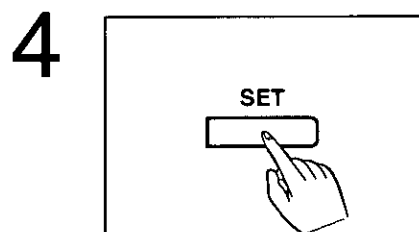

Press the **SET** button to store your selection into memory.

The **PROGRAM** indicator lights.

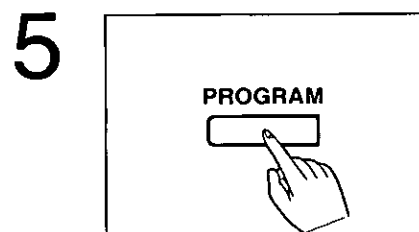

Press the **PROGRAM** button to end the operation.

The **PROGRAM** indicator goes out.

Setting the remote code (REMOTE ANS ID) for remote operation

The REMOTE ANS ID is used to access your answering device from a remote location with a touch tone phone (see pages 4-15 to 4-20).

Using this code, you can retrieve incoming messages recorded on the microcassette tape from a remote location.

The REMOTE ANS ID is preset to 111. If you wish to change the number, you can choose any number from 111 to 999 except numbers including "0".

For proper operation, make sure that the REMOTE ANS ID number is different from your PRIVACY RING ID number (see page 4-22).

HELPFUL HINT:

When you lose your procedures while programming, press the **HELP** button.

You will be able to print information about how to set.

1

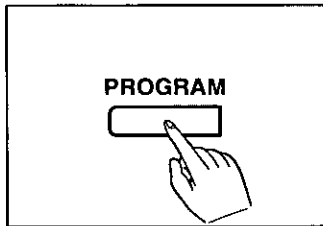

Press the **PROGRAM** button.

The PROGRAM indicator lights.

2

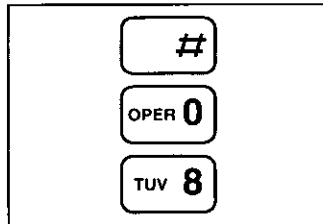

Press #, then press **08**.

The PROGRAM indicator flashes.

3

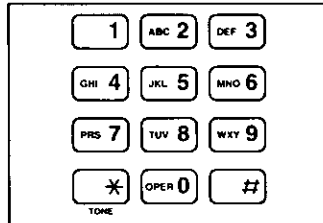

Enter the desired REMOTE ANS ID using the dial keypad.

To correct an error while programming, press the STOP/CLEAR button then repeat from step 2.

4

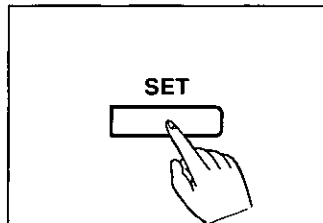

Press the **SET** button to store your selection into memory.

The PROGRAM indicator lights.

5

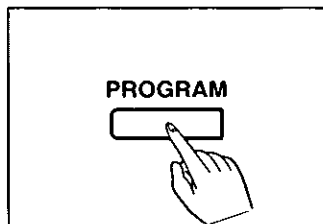

Press the **PROGRAM** button to end the operation.

The PROGRAM indicator goes out.

NOTE:

We recommend that you do not use seven (7) as a code number, since this number is used as the greeting message re-recording command for remote operations.

HELP Function —If you have lost your procedures—

The HELP button is used to print information about how to send documents, how to set up your unit and how to store phone numbers.

Using the HELP button

- Press the HELP button when the unit is in the idle status.
The following is printed out.

Sample of the Help Information

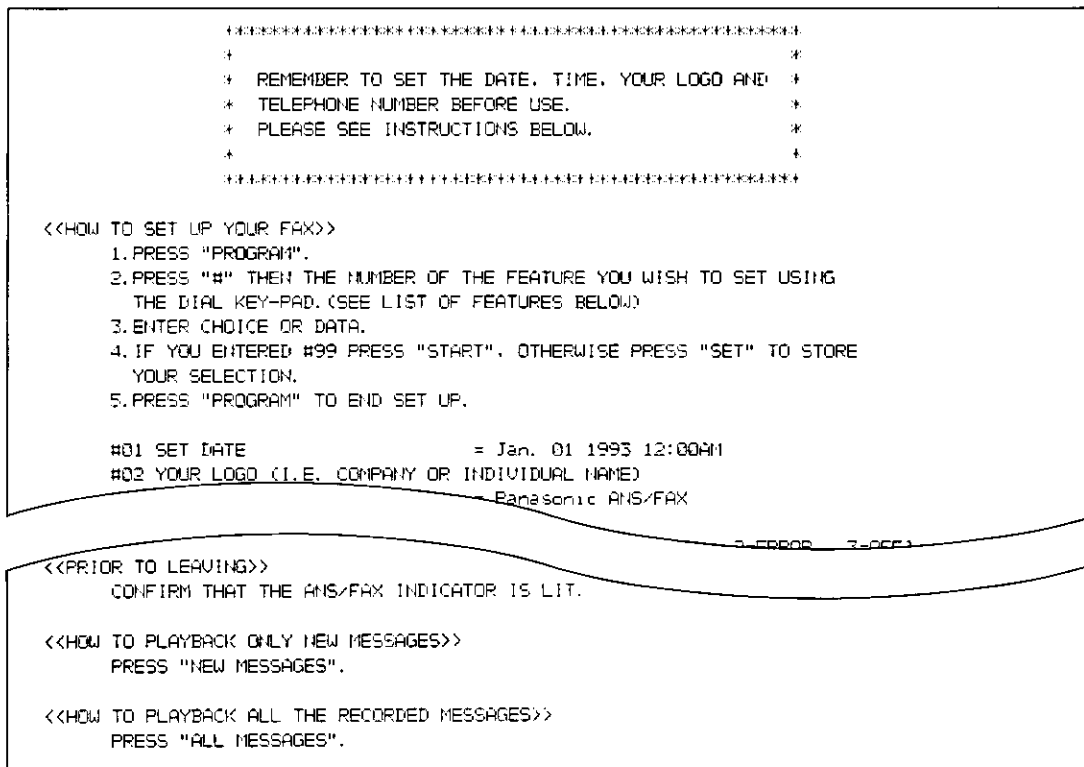

- Press the HELP button while programming each feature (#01 through #08, #10, #11 and #18).

Example: When you wish to program the SET DATE (#01),

1. Press the **PROGRAM** button.
The PROGRAM indicator lights.
2. Press #, then press **01** for SET DATE setting. The PROGRAM indicator flashes.
3. When you wish to know how to continue programming, press the **HELP** button.
The following is printed out.

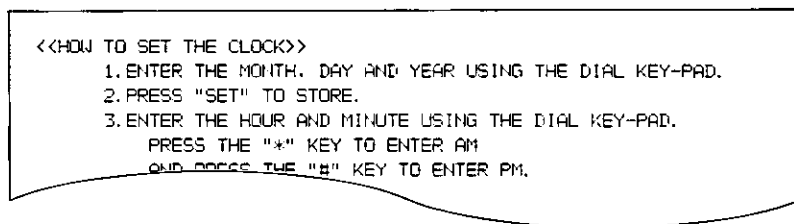

4. Resume programming.

Chapter 2

Basic Instructions

Table of Contents

<i>Facsimile and Copier</i>	<i>Answering Device</i>
Before Transmitting Documents 2-2	Operating as an Answering Device 2-10
Acceptable documents 2-2	Setup of voice message and document reception 2-11
Documents you cannot send 2-2	Listening to newly recorded messages 2-11
Resolution and contrast 2-3	Listening to all the recorded messages 2-12
Loading documents 2-3	Recording after the messages you want to save 2-12
Transmitting Documents 2-4	Monitoring incoming calls 2-13
Manual transmission 2-4	Recording a memo message 2-13
Adding extra pages 2-5	Recording a telephone conversation (2-way recording) 2-14
Receiving Documents and/or Voice Calls 2-6	
Manual reception 2-6	<i>Telephone</i>
Automatic reception 2-7	Making and Answering Voice Calls 2-15
Receiving in the ANS/FAX mode 2-7	Making voice calls 2-15
Receiving in the TEL/FAX mode 2-8	Redialing the last dialed number 2-16
Receiving in the FAX mode 2-8	Answering voice calls 2-16
Making a Copy 2-9	

Before Transmitting Documents

Acceptable documents

The unit can transmit documents that meet the following conditions.

- Documents width should be from 128 mm (5") to 216 mm (8½").
- Maximum document length should not exceed 600 mm (23⅝").
- Effective scanning width can be up to 208 mm (8⅜").
- Number of pages that can be set in the document feeder tray can be up to 10 sheets.
- Document weight:
 - Single sheet: 45 g/m² to 90 g/m² (12 pound to 24 pound)
 - Multiple sheets: 60 g/m² to 75 g/m² (16 pound to 20 pound)

Minimum document size

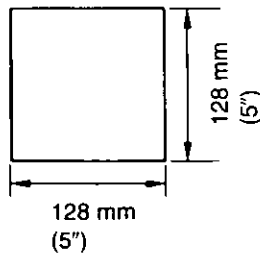

Maximum document size

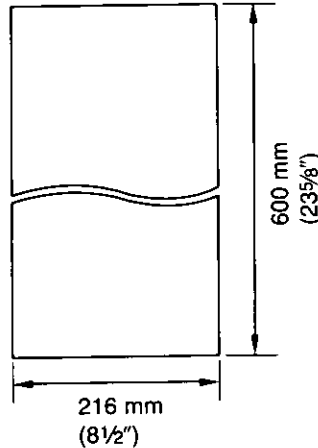

Effective scanning width

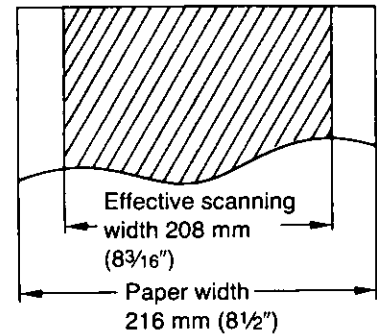

NOTES:

- A document whose length exceeds 600 mm (23⅝") cannot be transmitted. When you feed such documents, the unit will stop transmitting and a long beep will be heard. If this happens, press the STOP/CLEAR button and remove the document.
- If a document is electrostatically charged, the automatic document feeder may not function properly.

Documents you cannot send

Do not use the following types of documents or they may jam. Make a copy of such documents and feed the copy into the unit.

- Paper with a chemically treated surface such as carbon paper or carbonless duplicating paper
- Heavily curled, creased or torn paper
- Paper with a coated surface
- Small-sized paper such as a slip or voucher
- Thin paper less than 45 g/m² (12 pound)
- Thick paper over 90 g/m² (24 pound)
- Paper with faint contrast between the print and the background
- Paper with printing on the reverse side that can be seen through from the front (e.g. newspaper)

Resolution and contrast

You can set the following functions depending on the quality of an original. Set the functions before transmission or copying. If you set them during transmission, they will be effective from the next sheet transmitted.

RESOLUTION:

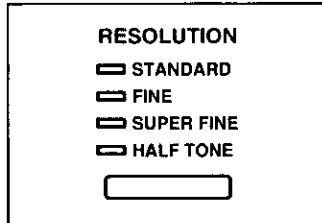

STANDARD is suitable for printed or typewritten originals with normal-sized characters.

FINE is suitable for originals with small printing.

SUPER FINE doubles the resolution of FINE.

(SUPER FINE only works between other KX-F160s or other Panasonic compatible machines.)

HALF TONE is useful when sending originals containing photographs, shaded drawings, etc.

LIGHT ORIGINAL:

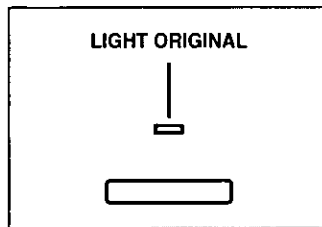

LIGHT ORIGINAL is useful when transmitting or copying originals with faint writing.

This feature does not work in the HALF TONE resolution.

Loading documents

Remove clips, staples or other similar objects from a document before feeding it into the unit. Check that all ink, paste or connection fluid on the document is completely dry before feeding it into the unit.

1

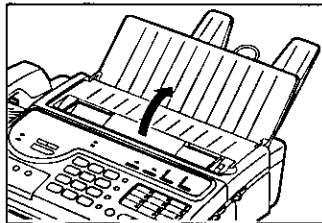

Open the document feeder tray.

2

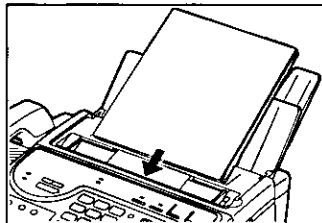

Insert the documents **FACE DOWN** into the document feeder tray.

The unit can accept up to 10 sheets of paper at a time.

3



Adjust the document guides to the width of the document.

4

Set the resolution or contrast setting if needed.

Transmitting Documents

Manual transmission

1

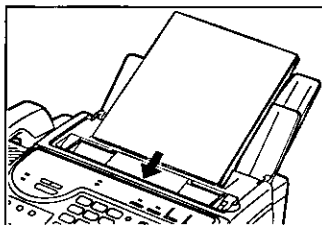

Insert the documents **FACE DOWN**.

The unit can accept up to 10 sheets of paper at a time.

2

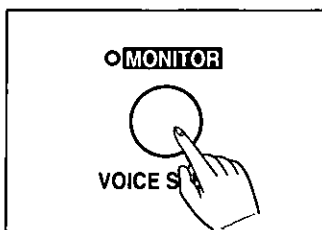

Press the **MONITOR** button or lift the handset.

3

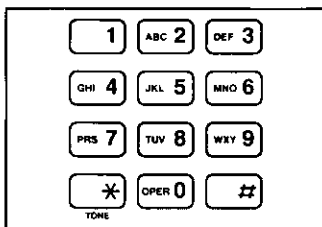

Dial the phone number of the party to which you wish to send.

If the other party answers, lift the handset and ask them to press their start or transmit button to start the fax reception.

4

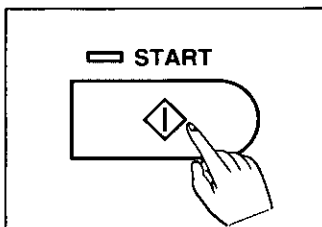

Press the **START** button when a fax tone is heard.

5

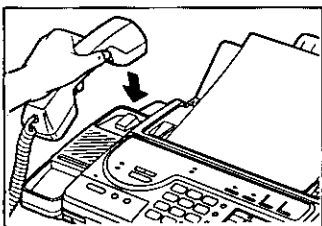

Place the handset on the cradle if using it.

The unit will feed and transmit the documents.

NOTES:

- If you do not replace the handset after pressing the START button, the unit will automatically call the other party upon finishing the transmission. For further details, see "Voice Contact" on page 4-24.
- If the line is busy, press the MONITOR button or hang up the handset if using it. Then try again later by using the REDIAL button in step 3.
- To interrupt transmission, press the STOP/CLEAR button until a beep sounds. Press the STOP/CLEAR button again to eject the document.

You can also access the other party's facsimile without using the handset or the MONITOR button.

This feature enables you to transmit a document with less procedures.

1

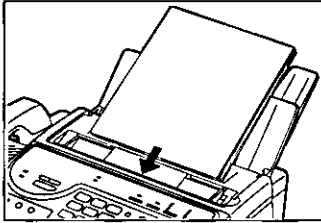

Insert the documents FACE DOWN.

2

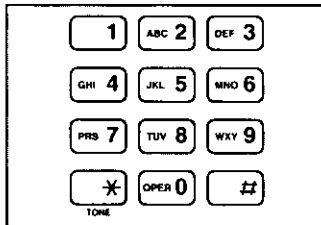

Enter the phone number of the party to which you wish to send.

If you misdialed, press the STOP/CLEAR button then enter the correct number.

3

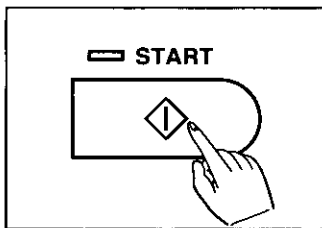

Press the **START** button.

The unit will dial and transmit the documents.

Automatic redialing feature:

If there is no answer or the line is busy, the unit will automatically redial the number up to 6 times. To cancel automatic redialing, press the STOP/CLEAR button.

NOTE:

To interrupt transmission, press the STOP/CLEAR button until a beep sounds. Press the STOP/CLEAR button again to eject the document.

Adding extra pages

If you want to send 11 or more sheets at a time, insert the first ten pages of the document and add the extra pages, up to 10 sheets at a time, before the last page is fed into the unit.

Receiving Documents and/or Voice Calls

Manual reception

When in the TEL mode or during a telephone conversation, you can receive fax documents as follows.

1



When the phone rings, lift the handset to answer the call.

2

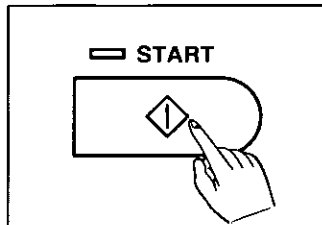

When a voice is heard and document reception is required, press the **START** button.

3

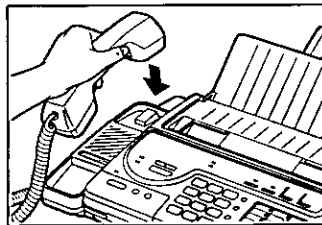

Place the handset on the cradle.

The unit will start receiving a document.

NOTES:

- If you do not replace the handset after pressing **START** button, the unit will automatically call the other party. For further details, see "Voice Contact" on page 4-24.
- To interrupt reception, press the **STOP/CLEAR** button. The unit will stop receiving.
- Replace the paper roll with a new one;
 - when the red lines appear on both sides of the recording paper.
 - when the **PAPER OUT** indicator lights.

Automatic reception

Set the RECEIVE MODE to any of the following modes:

- ANS/FAX mode
- TEL/FAX mode
- FAX mode

When receiving a fax call, the unit will automatically activate the fax function, then initiate reception.

Receiving in the ANS/FAX mode

1

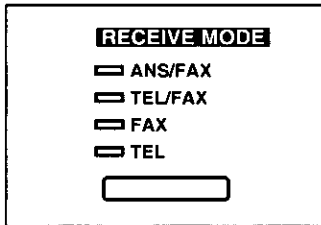

Make sure that the unit is in the ANS/FAX mode.

2



A call comes in.

The unit answers the call after 1 to 4 rings or no rings, depending on the number of rings after which the unit is set to answer (see page 1-29).

3

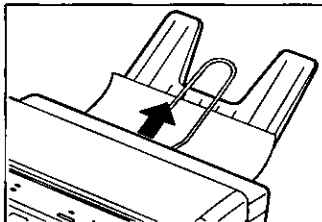

—When receiving a fax tone, the unit automatically activates the fax function to receive document.

—When receiving a voice-call, the unit plays your greeting message.

HELPFUL HINTS:

- If the other party wishes to leave you a message and transmit a document on the same call, let them know the following procedure in advance.

When the other party's line has touch tone service:

1. After leaving a message, the other party presses their * button. Your unit will switch to the FAX mode.
2. When a fax tone is heard, they start transmission by pressing their start or transmit button.

When the other party's line has rotary pulse service:

1. They start transmission by pressing their start or transmit button. Your unit starts reception.
2. They make a call reservation (e.g. ...lift the handset) during transmission of their document. Your unit plays your greeting message.
3. They leave a message after the long beep following your greeting message.

- Begin by transmitting the FAX CORRESPONDENCE leaflet found on page 6-15 to several of your associates. In this way you can confirm that your unit is functioning correctly and inform them of the procedure for transmitting documents and/or recording voice-message on your unit.

NOTE:

If you set the RINGER OFF through the ANS/FAX RING COUNT function, the extension phone connected to the unit will ring once when receiving a call. See page 1-29 for the RINGER OFF setting.

Receiving in the TEL/FAX mode

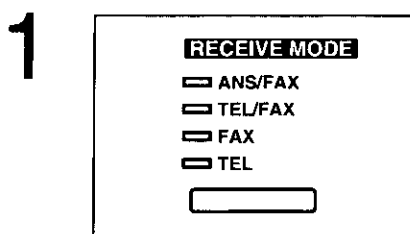

Make sure that the unit is in the TEL/FAX mode.

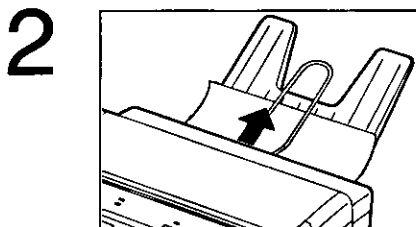

A call comes in.

—When receiving a fax tone, the unit automatically activates the fax function to receive documents.

OR



OR

—When receiving a telephone call, the unit rings 3 to 8 times, depending on the setting of the silent fax recognition ring (see page 4-29).
If a fax reception is required or nothing is heard, press the START button and hang up to receive a fax.
If someone does not pick up the phone, the unit will automatically activate the fax function to receive documents.

NOTES:

- A telephone fee is charged to callers from the first ring.
- When receiving a fax tone, the extension phone connected to the unit will ring once and then the unit automatically activates the fax function to receive documents.

Receiving in the FAX mode

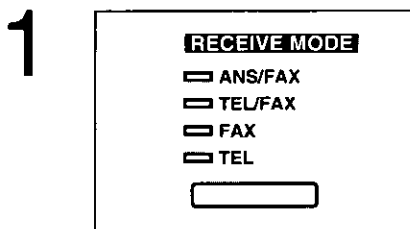

Make sure that the unit is in the FAX mode.

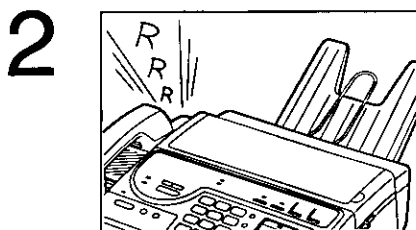

A call comes in.

The unit answers the call after 1 to 4 rings, depending on the number of rings after which the unit is set to answer (see page 1-31).

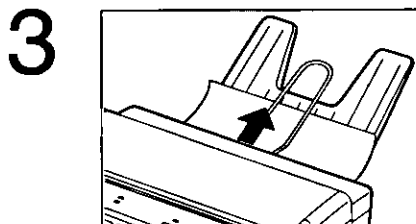

The unit produces a fax tone, then starts receiving a document when the other party presses their start or transmit button.

Making a Copy

The unit can make a copy. Any transmissible documents can be copied. Before sending a document, you can see how it will look to the receiving party in advance. When copying, the unit automatically selects the FINE resolution, but you may use SUPER FINE or HALF TONE resolution.

1

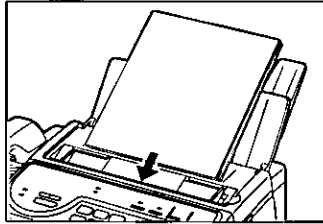

Insert the documents **FACE DOWN**.

The unit can accept up to 10 sheets of paper at a time.

2

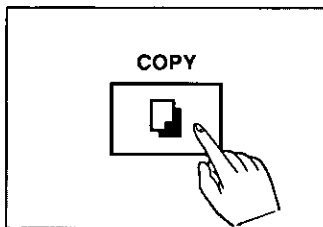

Press the **COPY** button.

The unit starts making a copy.

NOTES:

- If you wish to copy 11 or more sheets at a time, insert the first ten pages of the document and add the extra pages up to 10 sheets at a time, before the last page is fed into the unit.
- You can make or receive voice calls while making a copy.
- To stop making a copy on the way, press the STOP/CLEAR button. The unit stops copy operation. Press the STOP/CLEAR button again to eject the document.

Operating as an Answering Device

The unit also works as an automatic telephone answering and recording system.

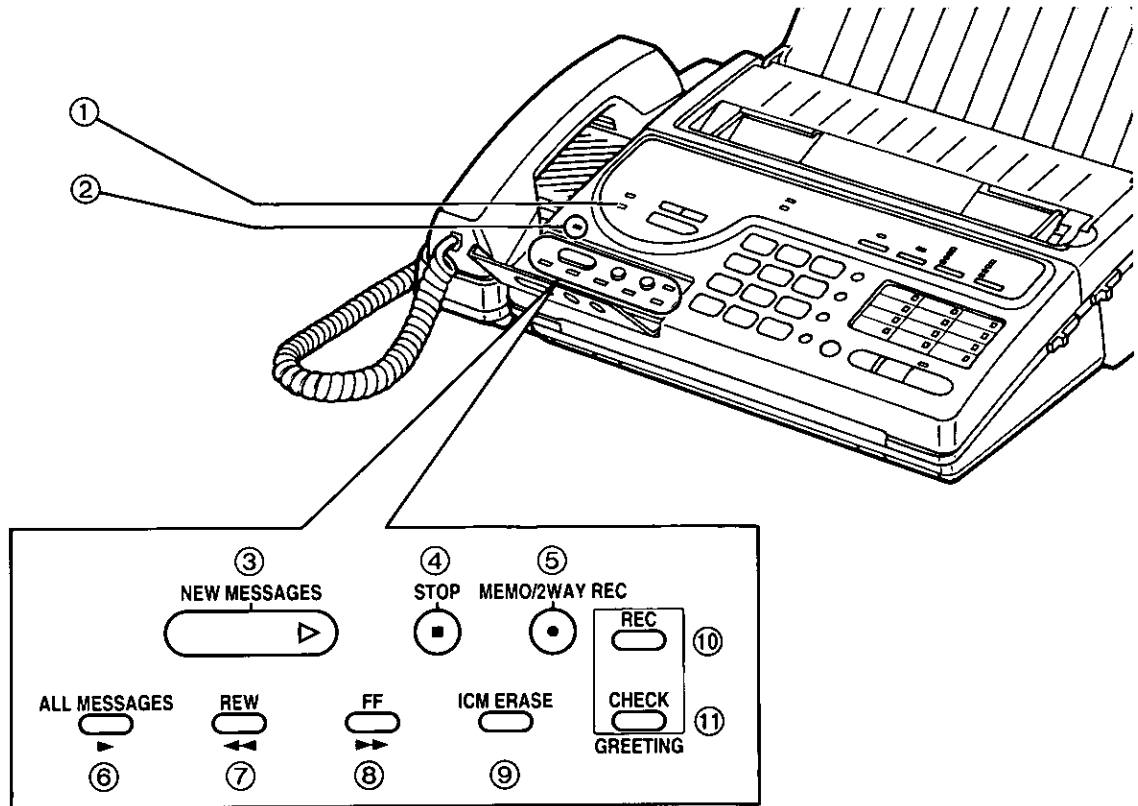

- ① **CALLS indicator:**
The indicator flashes to show the number of incoming messages recorded up to 15 times. Even if 16 or more calls are recorded, the indicator will flash up to 15 times.
If the power supply has been interrupted, the CALLS indicator flashes slowly when the power is restored.
- ② **IN USE indicator:**
When the answering device is in use, the indicator lights or flashes.
- ③ **Playing back newly recorded voice-messages:**
Press the **NEW MESSAGES** button.
See page 2-11.
- ④ **Stopping operations of the answering device:**
Press the **STOP** button.
- ⑤ **Recording a memo message:**
See page 2-13.
- ⑥ **Playing back all recorded messages:**
Press the **ALL MESSAGES** button.
See page 2-12.
- ⑦ **Rewinding (Resetting) the tape quickly:**
Press the **REW** (rewind) button.
- ⑧ **Advancing the tape quickly:**
Press the **FF** (fast forward) button.
- ⑨ **Erasing recorded voice-messages:**
After reviewing messages to you, press the **ICM ERASE** button. The messages are erased while the tape is rewinding.

The tape can be erased at high speed even if the record-prevention (knock-out) tabs have been removed.
- ⑩ **Recording your greeting message:**
See page 1-17.
- ⑪ **Checking your greeting message:**
See page 1-17.

Recording a telephone conversation:
See page 2-14.

Setup of voice message and document reception

1

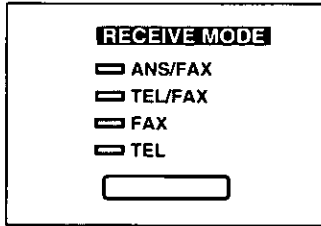

Press the **RECEIVE MODE** button until the ANS/FAX indicator lights.

2

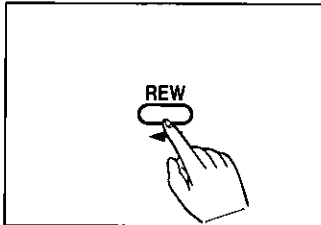

Press the **REW** button to record messages from the beginning of the tape.

When a call is received, the unit answers the call and begins playback of your greeting message. The unit automatically distinguishes between voice and fax calls, and then functions as an answering device and/or a facsimile.

NOTE:

The recording time for incoming messages can be set to VOX (unlimited) or 1 MIN (1 minute). It is preset to VOX. To change the recording time, see page 1-32.

Listening to newly recorded messages

When new incoming messages have been recorded, the CALLS indicator flashes to show the number of incoming message.

To play back only new messages:

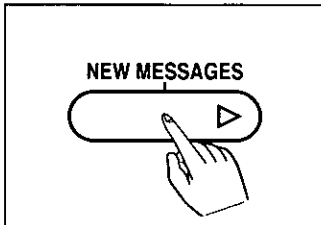

Press the **NEW MESSAGES** button.

The IN USE indicator lights and then the unit plays back new messages. At the end of the last message, 3 beeps sound and the tape stops automatically.

NOTES:

- The unit is equipped with the message alert feature. When this feature is set to on, the unit lets you know with a slow beep whether a caller's message has been recorded in the unit or not. To set this feature, see page 4-23.
- To interrupt the playback halfway, press the STOP button. To restart the playback, press the NEW MESSAGES button within one minute after pressing the STOP button. Or the unit will record over any existing messages.

Listening to all the recorded messages

All the recorded messages will be played back from the beginning of the tape.

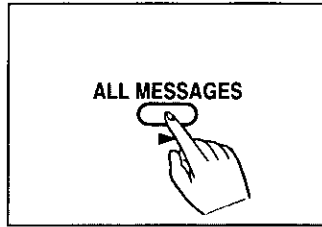

Press the **ALL MESSAGES** button.

The unit plays back all the recorded messages. At the end of the last message, 3 beeps sound and the tape stops automatically.

NOTES:

- To interrupt the playback halfway, press the STOP button.
- To restart the playback, press the ALL MESSAGES button within one minute after pressing the STOP button. Or the unit will record over any existing messages.

Recording after the messages you want to save

New incoming messages will be automatically stored after the last message. If you want to store incoming messages after your saved messages, proceed as follows.

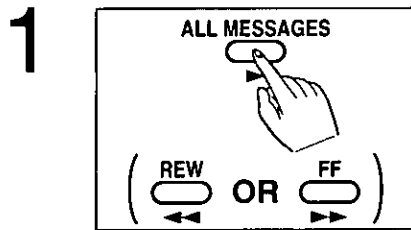

Play back the messages.

You may use the ALL MESSAGES, FF or REW button.

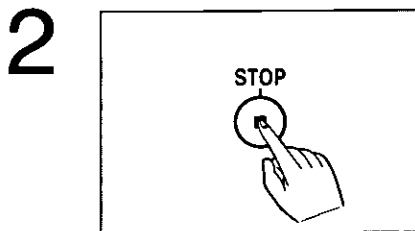

Press the **STOP** button at the end of the messages you want to save.

The IN USE indicator goes out.

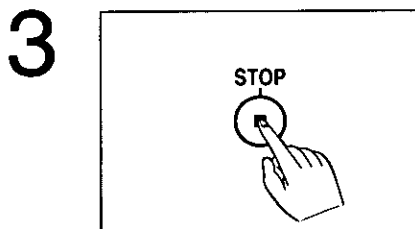

Press the **STOP** button again.
or
Leave the unit for one minute.

Future calls will be recorded after the message(s) you have saved.

Monitoring incoming calls

While an incoming message is being recorded, you can monitor the caller's voice through the built-in speaker and answer it if you want.

Adjust the sound level using the VOLUME control.

To answer the call while monitoring, lift the handset. The unit stops recording automatically.

Recording a memo message

If you are going out and want to leave a private message for someone, you can record a voice memo in the unit. This can then be played back either directly or remotely, exactly like any other incoming message.

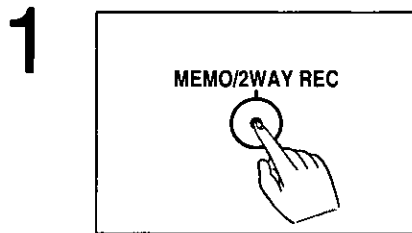

Press the **MEMO/2WAY REC** button.

The IN USE indicator lights and a beep is heard.

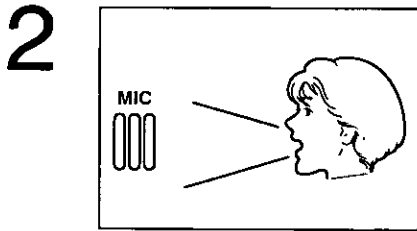

Speak toward the microphone from approximately 20 cm (8 inches) away.

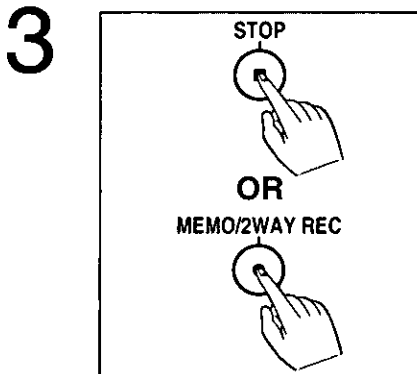

To stop recording, press the **STOP** button or the **MEMO/2WAY REC** button again.

The IN USE indicator goes out.

Recording a telephone conversation (2-way recording)

While speaking with someone on the telephone, you can record your conversation.

1

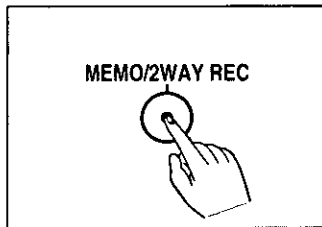

During your conversation, press the **MEMO/2WAY REC** button.

The **IN USE** indicator lights and a beep is heard.

2

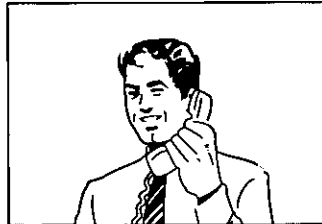

Continue your conversation.

3

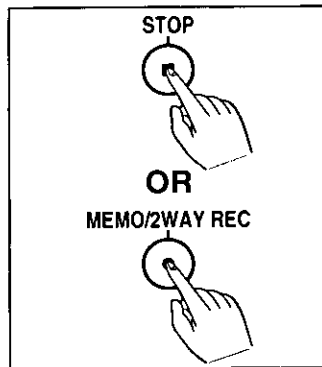

To stop recording, press the **STOP** button or the **MEMO/2WAY REC** button again.

The **IN USE** indicator goes out.

NOTE:

Many states have imposed regulations on the manner in which 2-way telephone conversations may be recorded. So you should inform the other party that the conversation is being recorded. Consult your local telephone company for further information.

Making and Answering Voice Calls

Making voice calls

Using the handset

1. Lift the handset.
2. Dial the phone number.

Using on-hook dialing

1

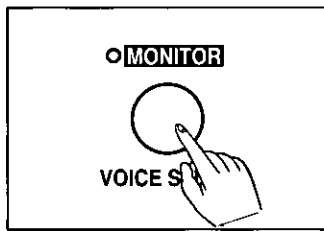

Press the **MONITOR** button.

The **MONITOR** indicator lights.

2

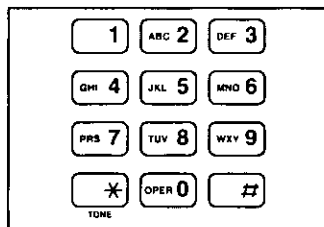

Dial the phone number.

3



When the other party answers your call, lift the handset and talk with it.

Redialing the last dialed number

If the line is busy or you wish to redial the last dialed number, you can redial by pressing the REDIAL button.

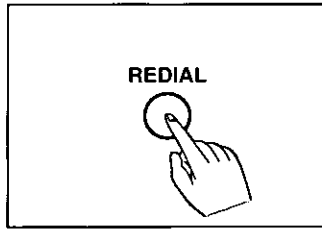

Press the **REDIAL** button.

- When using the handset**, the unit redials the last dialed number once.
- When using on-hook dialing**, the unit redials the last dialed number up to 15 times within 10 minutes if the line is busy (automatic redialing feature).

Answering voice calls

When the phone rings, lift the handset to answer the call.

Chapter 3

Intermediate Instructions

Table of contents

Storing Phone Numbers for Automatic Dialing	3-2
Listing the directory card	3-2
Storing phone numbers for one touch dialing	3-3
Storing phone numbers for speed dialing	3-4
Storing secret phone numbers	3-5
Erasing a stored phone number	3-6

Facsimile

Transmitting Documents Using Automatic Dialer	3-7
--	-----

Telephone

Making Voice Calls Using Automatic Dialer	3-8
--	-----

Storing Phone Numbers for Automatic Dialing

The unit's memory allows you to use both one touch dialing (up to 12 phone numbers) and speed dialing (up to 10 phone numbers) for rapid access to your most frequently dialed numbers. First make sure the DIALING MODE selector is set to TONE or PULSE (rotary) mode, since the number will be stored in the mode that is set at the time of programming.

HELPFUL HINT:

When you lose your procedures while programming, press the HELP button. You will be able to print information about how to set.

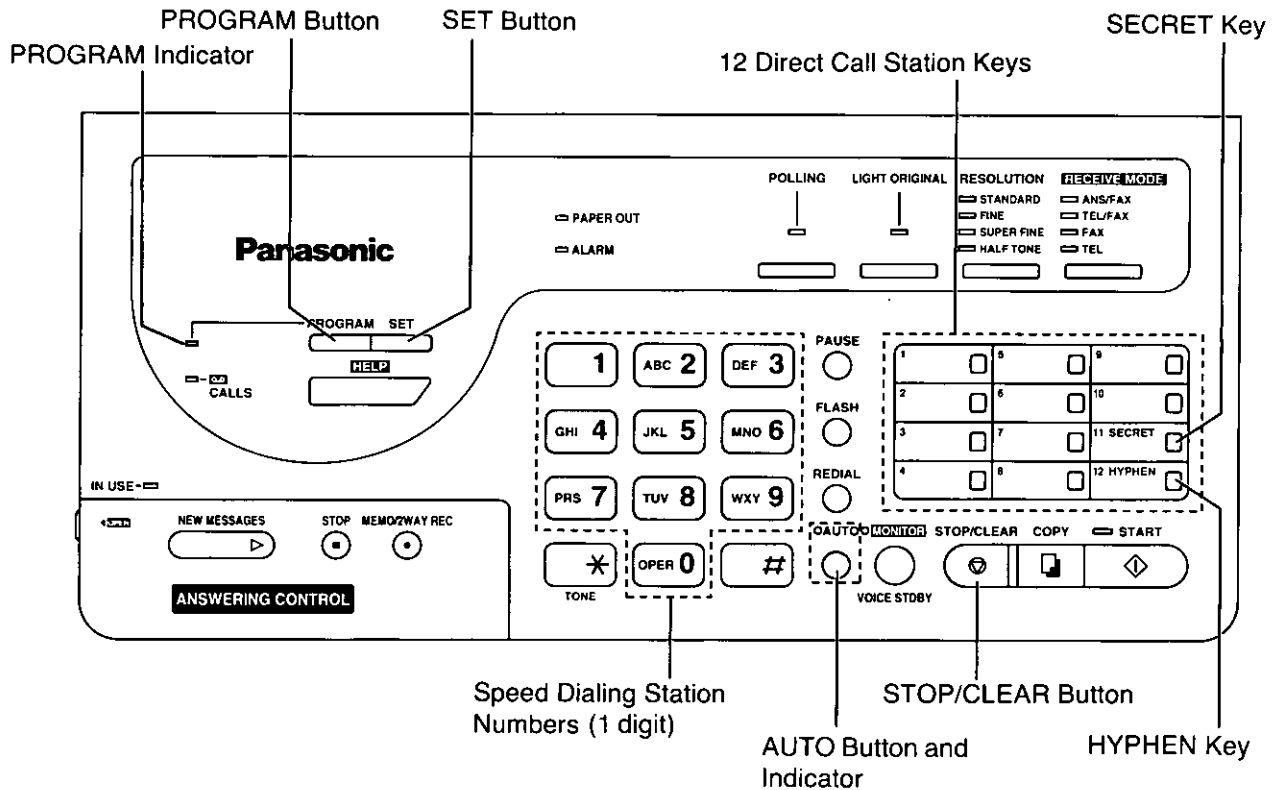

Listing the directory card

1. Remove the cover using an instrument with a pointed end, like a pen, as shown below.
2. Remove the directory card.
3. Write in the names associated with the direct call station keys.
4. Re-install the directory card.

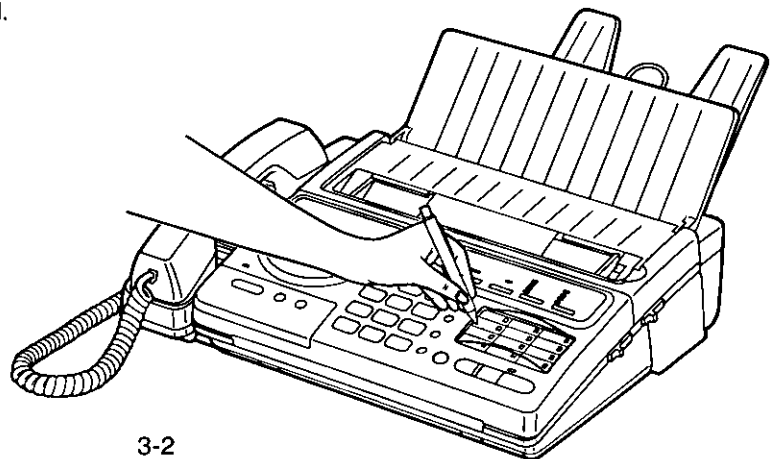

Storing phone numbers for one touch dialing

This unit is equipped with 12 direct call station keys including SECRET and HYPHEN keys, each of which can store a telephone number. Each phone number can be programmed up to 30 digits long.

1

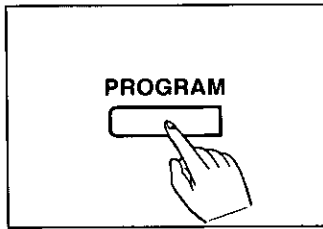

Press the **PROGRAM** button.

The PROGRAM indicator lights.

2

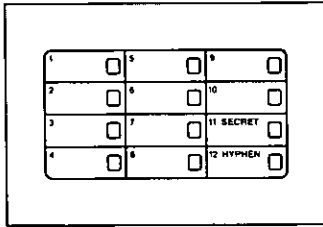

Press one of the direct call station keys where you want to store the phone number.

The PROGRAM indicator flashes.

3

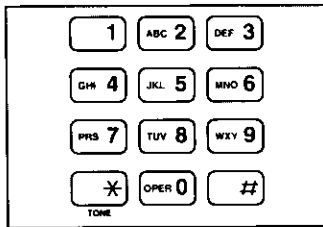

Enter the phone number by using the dial keypad.

If you want to insert a hyphen in the number, press the HYPHEN key during programming. HYPHEN is counted as 2 digits.

4

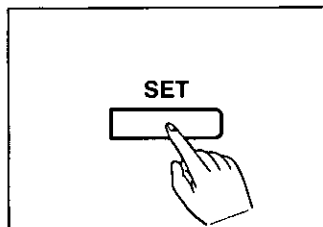

Press the **SET** button to store the program into memory.

The PROGRAM indicator lights.

To store in succession, repeat steps 2 to 4.

5

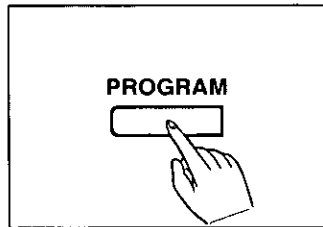

After programming all numbers, press the **PROGRAM** button to end the operation.

The PROGRAM indicator goes out.

NOTES:

- While storing, pressing the PAUSE or FLASH or TONE button once counts 1 digit.
- To correct an error while programming, press the STOP/CLEAR button then repeat from step 2.
- To cancel the programming halfway, press the PROGRAM button.
- To print out a list of the stored phone numbers, press the PROGRAM button, press #, then press 27, then press the START button. For further details, see pages 5-5 and 5-6.

Storing phone numbers for speed dialing

The unit is equipped with 10 stations (0 through 9), each of which can store a phone number. Each phone number can be programmed up to 30 digits long.

1

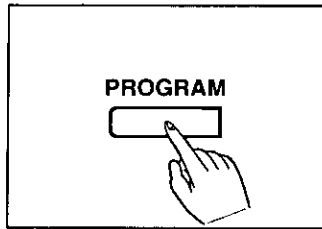

Press the **PROGRAM** button.

The PROGRAM indicator lights.

2

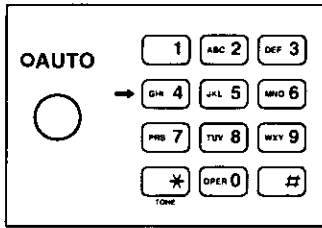

Press the **AUTO** button.

The AUTO indicator lights.

Enter the 1-digit number (0 through 9) by using the dial keypad.

The PROGRAM indicator flashes.

3

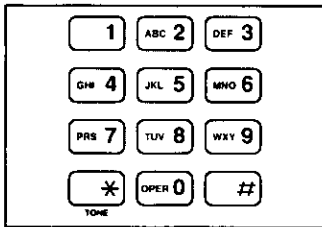

Enter the phone number by using the dial keypad.

To insert a hyphen in the number, press the HYPHEN key during programming. HYPHEN is counted as 2 digits.

4

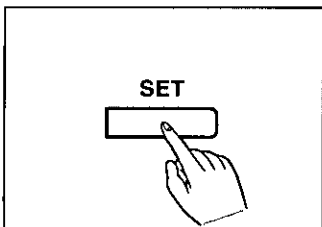

Press the **SET** button to store the program into memory.

The AUTO indicator goes out and the PROGRAM indicator lights.

To store in succession, repeat steps 2 to 4.

5

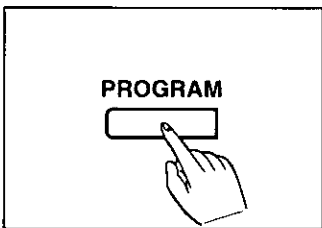

After programming all the numbers, press the **PROGRAM** button to end the operation.

The PROGRAM indicator goes out.

NOTES:

- To correct an error while programming, press the STOP/CLEAR button then repeat from step 2.
- To cancel the programming halfway, press the PROGRAM button.
- To print out a list of the stored phone numbers, press the PROGRAM button, press #, then press 27, then press the START button. For further details, see pages 5-5 and 5-6.

Storing secret phone numbers

This function is useful for keeping a whole phone number or a portion of a phone number secret. When you print out a list of the stored numbers, secret numbers will not be printed.

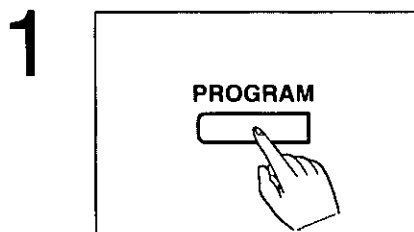

Press the **PROGRAM** button.

The PROGRAM indicator lights.

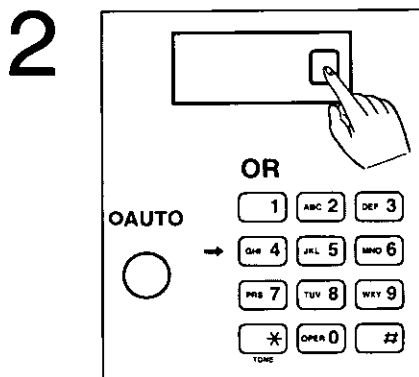

Press one of the direct call station keys.

OR

Press the **AUTO** button.

The AUTO indicator lights.

Then enter the 1-digit number (0 through 9).

The PROGRAM indicator flashes.

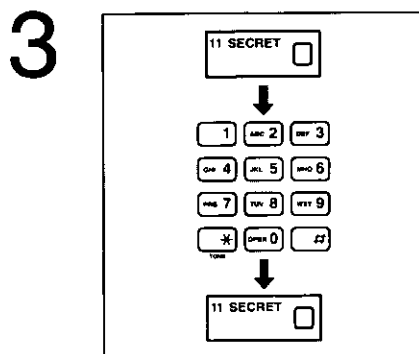

Press the **SECRET** key.

Then enter the phone number.

Then press the **SECRET** key again.

Pressing the SECRET key once counts as 2 digits.

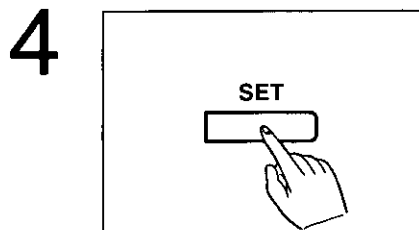

Press the **SET** button to store the program into memory.

The PROGRAM indicator lights.

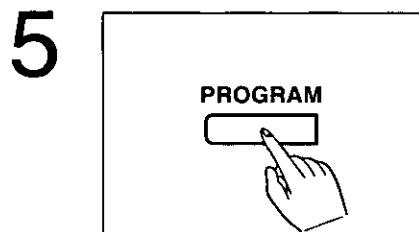

Press the **PROGRAM** button to end the operation.

The PROGRAM indicator goes out.

NOTES:

- To correct an error while programming, press the STOP/CLEAR button then repeat from step 2.
- To cancel the programming halfway, press the PROGRAM button.

Erasing a stored phone number

If you wish to erase a stored phone number, proceed as follows.

1

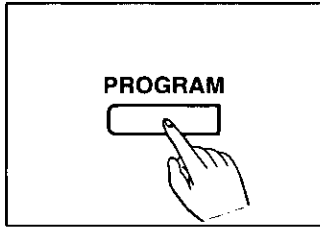

Press the **PROGRAM** button.

The PROGRAM indicator lights.

2

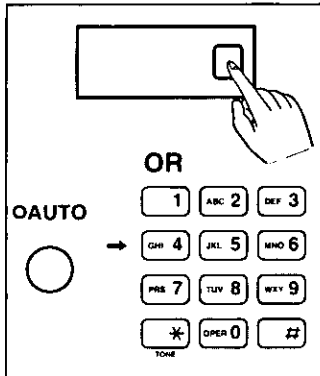

Press one of the direct call station keys.

OR

Press the **AUTO** button.

The AUTO indicator lights.

Then enter the 1-digit number (0 through 9).

The PROGRAM indicator flashes.

3

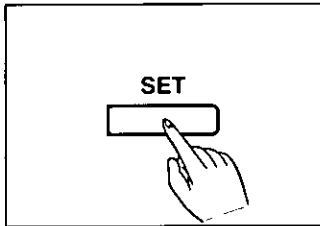

Press the **SET** button.

Now the stored phone number has been erased.

The PROGRAM indicator lights.

4

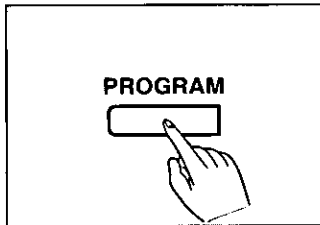

Press the **PROGRAM** button to end the operation.

The PROGRAM indicator goes out.

NOTE:

To cancel the programming halfway, press the PROGRAM button.

Transmitting Documents Using Automatic Dialer

You can transmit documents automatically using one touch dialing and speed dialing. Before using these features, make sure that the desired telephone numbers have been stored into memory. For storing phone numbers, see pages 3-3 to 3-5.

1

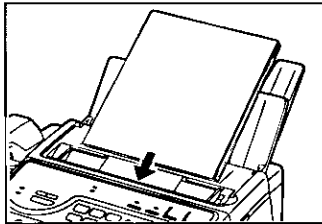

Insert the documents FACE DOWN.

The unit can accept up to 10 sheets of paper at a time.

2

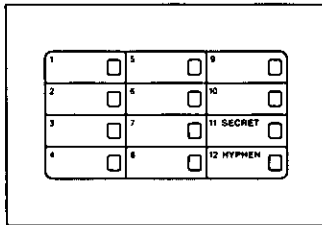

Using one touch dialing:

Press the desired direct call station key.

The unit dials and transmits the documents automatically.

OR

OR

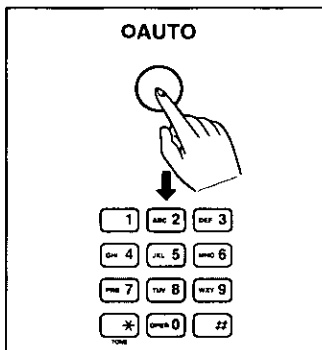

Using speed dialing:

Press the **AUTO** button.

Then enter the desired 1-digit number (0 through 9) by using the dial keypad.

The unit dials and transmits the documents automatically.

Automatic redialing feature:

If there is no answer or the line is busy, the unit will automatically redial the number up to 6 times. To cancel automatic redialing, press the STOP/CLEAR button.

NOTE:

To interrupt transmission, press the STOP/CLEAR button until a beep sounds. Press the STOP/CLEAR button again to eject the document.

Making Voice Calls Using Automatic Dialer

The unit's memory allows you to use both one touch dialing (up to 12 phone numbers) and speed dialing (up to 10 phone numbers) for rapid access to your most frequently called numbers. Before using these features, make sure that the desired telephone numbers have been stored in memory (see pages 3-3 to 3-5).

1

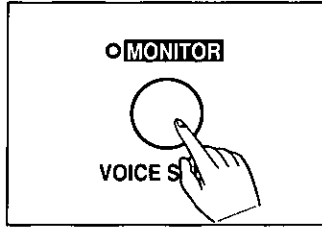

Press the **MONITOR** button or lift the handset.

2

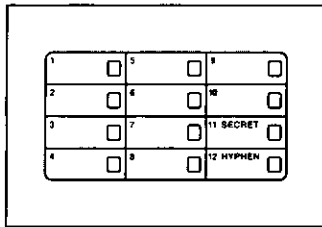

Using one touch dialing:

Press the desired direct call station key.

OR

OR

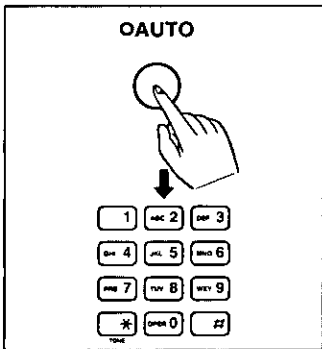

Using speed dialing:

Press the **AUTO** button.

Then press the desired station number (0 through 9) by using the dial keypad.

3



When the other party answers your call, lift the handset and talk with it.

Chapter 4

Advanced Instructions

Table of contents

<i>Facsimile and Copier</i>		Recording a marker message	4-17
Polling	4-2	Resetting the tape for future messages	4-18
Polling another unit manually	4-2	Room monitor	4-19
Polling another unit using automatic dialer	4-3	Skipping the greeting message for incoming message recording mode	4-19
Setting the polling password	4-4	Re-recording a greeting message	4-20
Network Communication	4-5	Call with Privacy Ring	4-21
Using a passcode	4-6	Calling with the privacy ring	4-21
Programming the main passcode	4-7	Programming the PRIVACY RING ID	4-22
Turning the TX passcode check on	4-8	Setting the Message Alert	4-23
Turning the RX passcode check on	4-9		
Remote Fax Receiving Using an Extension Phone	4-10	<i>Telephone</i>	
Using an extension phone	4-10	Voice Contact	4-24
Programming a remote fax activation code	4-11	Initiating voice contact	4-24
Setting the Logo Print Position	4-12	Receiving a request for voice contact	4-24
Setting a Customized Header	4-13	TONE, FLASH and PAUSE Button Usage	4-25
		TONE button (Temporary tone dialing)	4-25
		FLASH button	4-25
		PAUSE button	4-26
		Combination dialing	4-26
<i>Answering Device</i>		<i>Other Features</i>	
Operating an Answering Device from a Remote Phone	4-15	Other Features	4-27
Summary of remote control functions	4-15	Setting Day/Night Mode	4-27
Playing back newly recorded messages (Memory playback)	4-16	Setting the Silent Fax Recognition Ring	4-29
Playing back all messages	4-16	Resetting the setup features	4-30
Back space and skip forward	4-17		

Polling

Polling means that you call another facsimile machine (we call it “polled machine”) to retrieve a document. The other party must be prepared for your call with a document loaded on their machine.

This unit can only receive polled documents; it cannot be “polled”.

The unit initiating the call incurs any long distance charges.

Polling another unit manually

The following procedure lets you poll another station.

Make sure that no documents have been fed into the unit and that the polled machine is ready for your call.

1

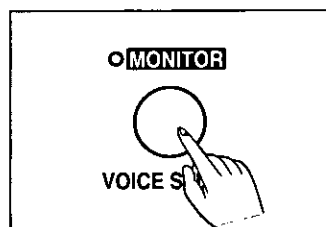

Press the **MONITOR** button or lift the handset.

2

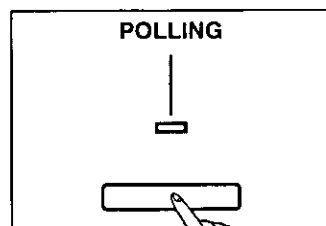

Press the **POLLING** button.

The **POLLING** indicator lights.

3

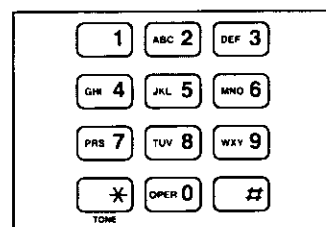

Enter the phone number of the unit you wish to poll.

4

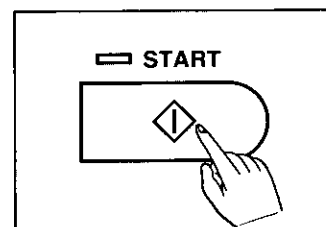

Press the **START** button when a fax tone is heard.

The unit will start polling.

After reception, the **POLLING** indicator goes out.

NOTE:

Cancel polling before reception by pressing the **STOP/CLEAR** button.

Polling another unit using automatic dialer

Make sure that the desired telephone numbers have been stored into memory (see pages 3-3 through 3-5).

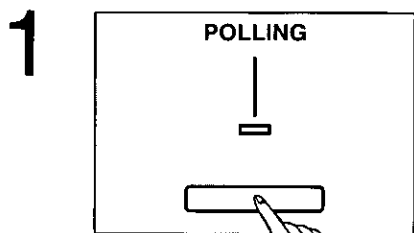

Press the **POLLING** button.
The POLLING indicator lights.

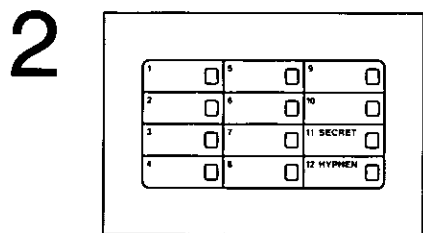

Using one touch dialing:
Press the desired direct call station key.

The unit will dial and receive documents automatically.
When reception ends, the POLLING indicator goes out.

OR

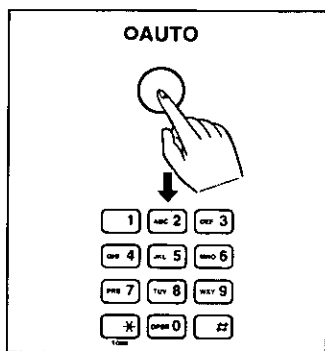

Using speed dialing:
Press the **AUTO** button.
Enter the desired 1-digit number (0 through 9) by using the dial keypad.

The unit will dial and receive documents automatically.
When reception ends, the POLLING indicator goes out.

NOTES:

- If the polled station is busy or there is no answer, the unit will automatically redial the number up to 6 times.
- Cancel polling before reception by pressing the STOP/CLEAR button.

Setting the polling password

If the document to be retrieved is of a confidential nature and the password is set on the other machine to prevent unauthorized retrieving, you must set the same password on your unit. If the passwords in the polling unit and polled unit do not match, no transmission will take place.

NOTES:

- Polling using a password is effective between other Panasonic compatible facsimile machines (e.g. KX-F60, KX-F90, KX-F110, KX-F5000).
- If the polling password is set to "0000", the unit does not check the password sent by other facsimile machines.

1

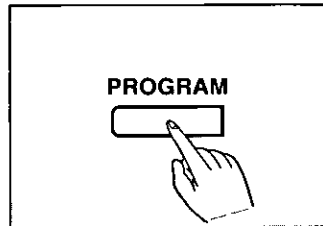

Press the **PROGRAM** button.

The PROGRAM indicator lights.

2

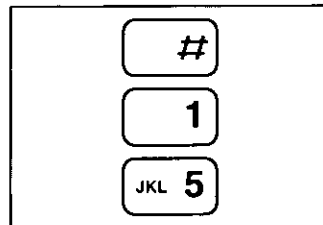

Press #, then press **15**.

The PROGRAM indicator flashes.

3

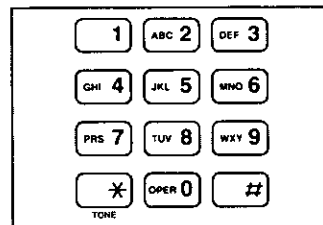

Enter your polling password of 4 digits by using the dial keypad.

4

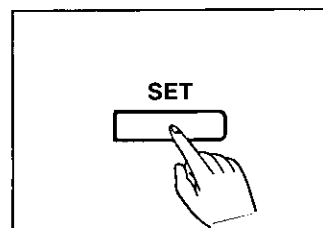

Press the **SET** button to store the program into memory.

The PROGRAM indicator lights.

5

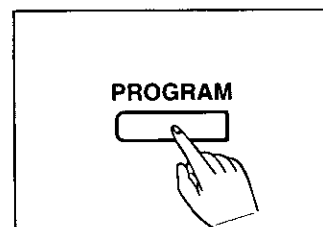

Press the **PROGRAM** button to end the operation.

The PROGRAM indicator goes out.

Network Communication

The main passcode network communication feature eliminates fax transmission to unauthorized parties, and helps to prevent reception from an unauthorized station.

This feature is effective to prevent “Junk mail” faxes since only those units with the same passcode can transmit to your unit.

When the network communication feature is used, the identical main passcode of 4 digits must be programmed on both sides of the line. The unit checks the passcode before transmitting or receiving a document.

The unit provides two types of passcode check modes. They are TX (transmission) passcode check mode and RX (reception) passcode check mode.

■ TX Passcode Check:

Use this feature to restrict document transmission. If the passcode sent from the other Panasonic compatible machines does not match with the one programmed in your unit, transmission does not take place (see page 4-8 for TX passcode check setting).

■ RX Passcode Check:

Use this feature to restrict document reception. If the passcode sent from the other Panasonic compatible machines does not match with the one programmed in your unit, reception does not take place (see page 4-9 for RX passcode check setting).

NOTES:

- These features are effective only between Panasonic compatible machines that have the same passcode.
- The password for the polling feature is not related to this network communication feature. They are independent features.

Using a passcode

Before communication begins, check that your passcode and the other station's passcode are identical.

■ When you want to transmit a document to a designated station only:

Set TX PASSCODE CHECK to ON.

Function	Your unit	Other Panasonic compatible machine
TX PASSCODE CHECK	ON	ON/OFF
RX PASSCODE CHECK	OFF	ON/OFF

Your unit transmits a document only when the correct passcode has been received.

■ When you want to receive a document from a designated station only:

Set RX PASSCODE CHECK to ON.

Function	Your unit	Other Panasonic compatible machine
TX PASSCODE CHECK	OFF	ON/OFF
RX PASSCODE CHECK	ON	ON/OFF

Your unit receives a document only when the correct passcode has been received.

■ When you want to have facsimile communications within a designated group of people:

All the people in the group must set both TX PASSCODE CHECK and RX PASSCODE CHECK to ON.

Function	Your unit	Other Panasonic compatible machine
TX PASSCODE CHECK	ON	ON
RX PASSCODE CHECK	ON	ON

Only units that share identical passcodes can transmit and receive documents with each other.

Programming the main passcode

To activate this feature, the identical main passcode must be preprogrammed both on your unit and the other Panasonic compatible machine(s).
 The main passcode may be any 4-digit number except 0000.

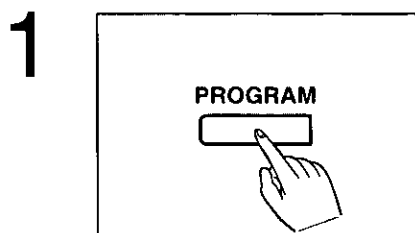

Press the **PROGRAM** button.
 The PROGRAM indicator lights.

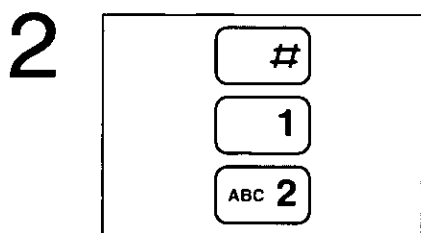

Press #, then press **12**.
 The PROGRAM indicator flashes.

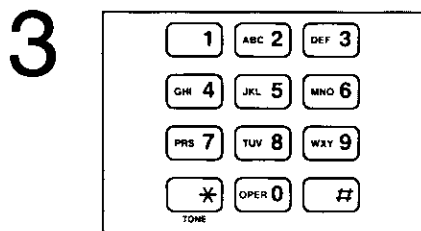

Enter the desired passcode of 4 digits using the dial keypad.

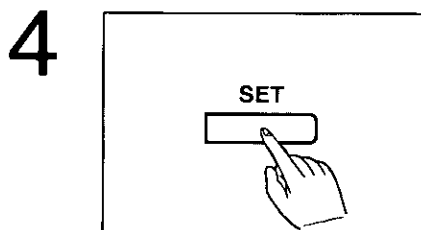

Press the **SET** button to store the program into memory.
 The PROGRAM indicator lights.

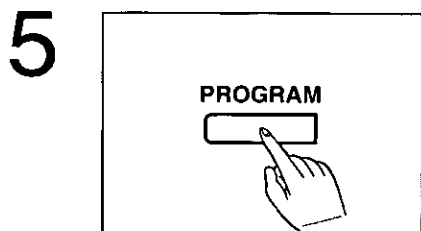

Press the **PROGRAM** button to end the operation.
 The PROGRAM indicator goes out.

Turning the TX passcode check on

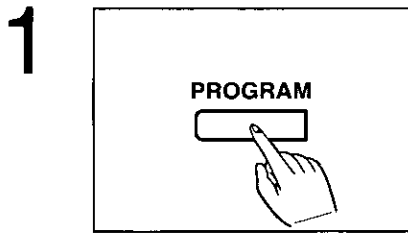

Press the **PROGRAM** button.
The PROGRAM indicator lights.

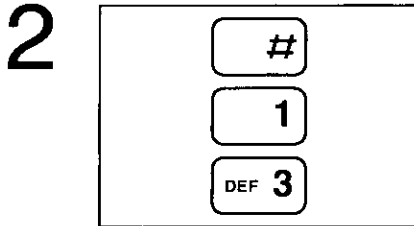

Press #, then press 13.
The PROGRAM indicator flashes.

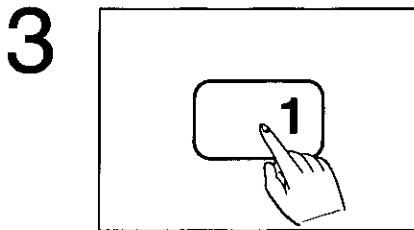

Press 1 to activate this feature.
Setting selections are:
1: ON (activate this feature)
2: OFF (deactivate this feature)

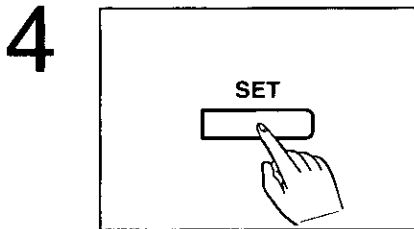

Press the **SET** button to store your selection into memory.
The PROGRAM indicator lights.

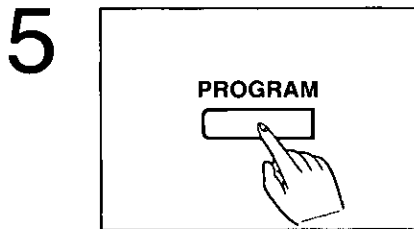

Press the **PROGRAM** button to end the operation.
The PROGRAM indicator goes out.

NOTE:

If the network passcode is set to "0000", this feature does not work properly.

Turning the RX passcode check on

1

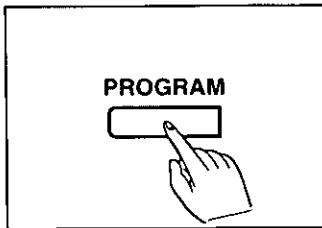

Press the **PROGRAM** button.

The PROGRAM indicator lights.

2

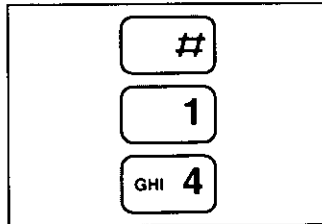

Press #, then press 14.

The PROGRAM indicator flashes.

3

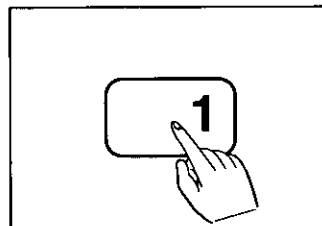

Press 1 to activate this feature.

Setting selections are:

- 1: ON (activate this feature)
- 2: OFF (deactivate this feature)

4

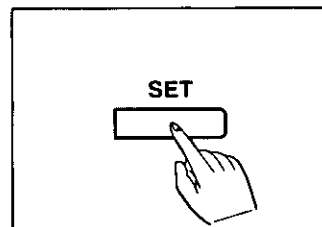

Press the **SET** button to store your selection into memory.

The PROGRAM indicator lights.

5

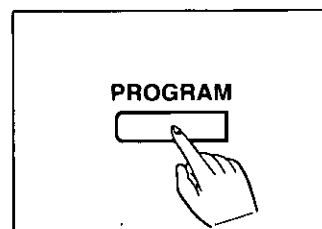

Press the **PROGRAM** button to end the operation.

The PROGRAM indicator goes out.

NOTE:

If the network passcode is set to "0000", this feature does not work properly.

Remote Fax Receiving Using an Extension Phone

If you connect an extension to the same line to which your facsimile unit is connected, it is possible to receive a fax document into your facsimile unit by using the extension telephone near you.

This saves you the trouble of going to the facsimile unit and pressing the START button.

NOTES:

- This feature is only effective when you receive a call.
- To activate this feature, use a touch tone telephone as an extension phone.

Using an extension phone

1

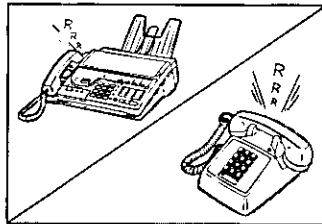

A call comes in.

2



Lift the handset of the extension phone.

3

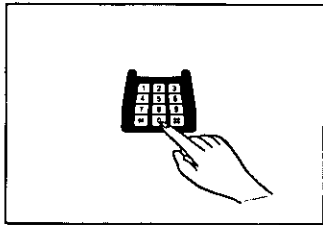

If a fax tone is heard, or the other party wishes to send you a fax, press * and * on the extension phone. Then replace the handset on the cradle.

4

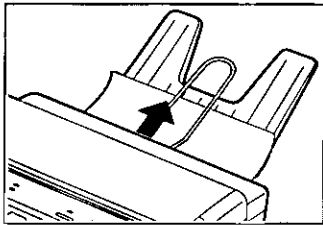

The unit will switch to the FAX mode, then receive a document.

NOTE:

Two *s can be changed to another 2 to 4-digit number. See page 4-11.

Programming a remote fax activation code

Your code can be from 2 to 4 digits long. The numbers 0 through 9 and characters # and * may be used. (e.g. **, 123, 123#)

1

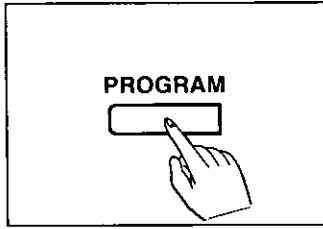

Press the **PROGRAM** button.

The PROGRAM indicator lights.

2

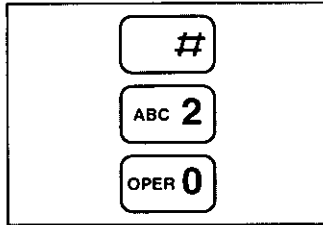

Press #, then press **20**.

The PROGRAM indicator flashes.

3

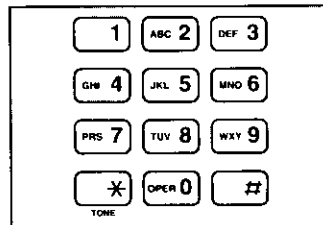

Enter the new code number using the dial keypad.

4

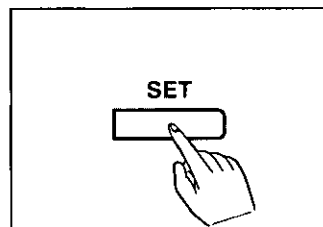

Press the **SET** button to store your program into memory.

The PROGRAM indicator lights.

5

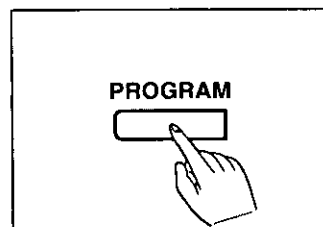

Press the **PROGRAM** button to end the operation.

The PROGRAM indicator goes out.

Setting the Logo Print Position

Your logo, telephone number, date, time and page number will be printed on the transmitted document from your unit in the following condition.

OUT: Outside of the transmitted document's paper size (default).

IN: Inside of the transmitted document's paper size.

OFF: Not printed.

To change the logo position:

HELPFUL HINT:

When you lose your procedures while programming, press the **HELP** button. You will be able to print information about how to set.

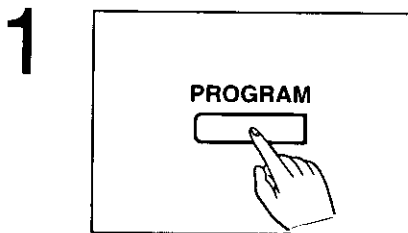

Press the **PROGRAM** button.

The PROGRAM indicator lights.

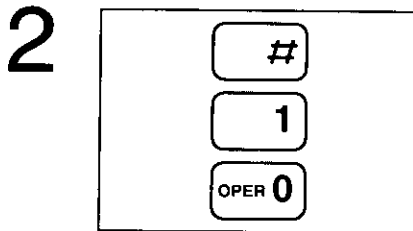

Press #, then press **10**.

The PROGRAM indicator flashes.

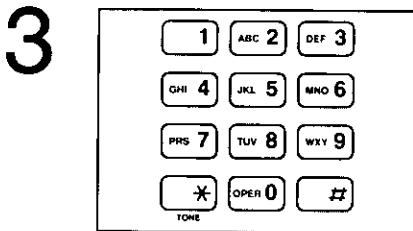

Press the number of the selection you desire.

Setting selections are:

1: OUT

2: IN

3: OFF

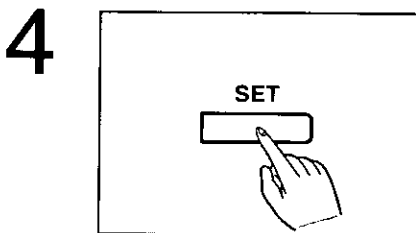

Press the **SET** button to store your selection.

The PROGRAM indicator lights.

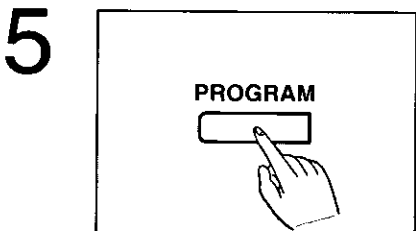

Press the **PROGRAM** button to end the operation.

The PROGRAM indicator goes out.

Setting a Customized Header

A special message that is preprogrammed in your unit can be printed at the top of all pages transmitted.

You can choose the desired message among the following.

- A: CONFIDENTIAL
- B: URGENT REPLY REQUEST
- C: URGENT PLEASE READ

Sample page transmitted from your unit

Example: The message "CONFIDENTIAL" is printed.

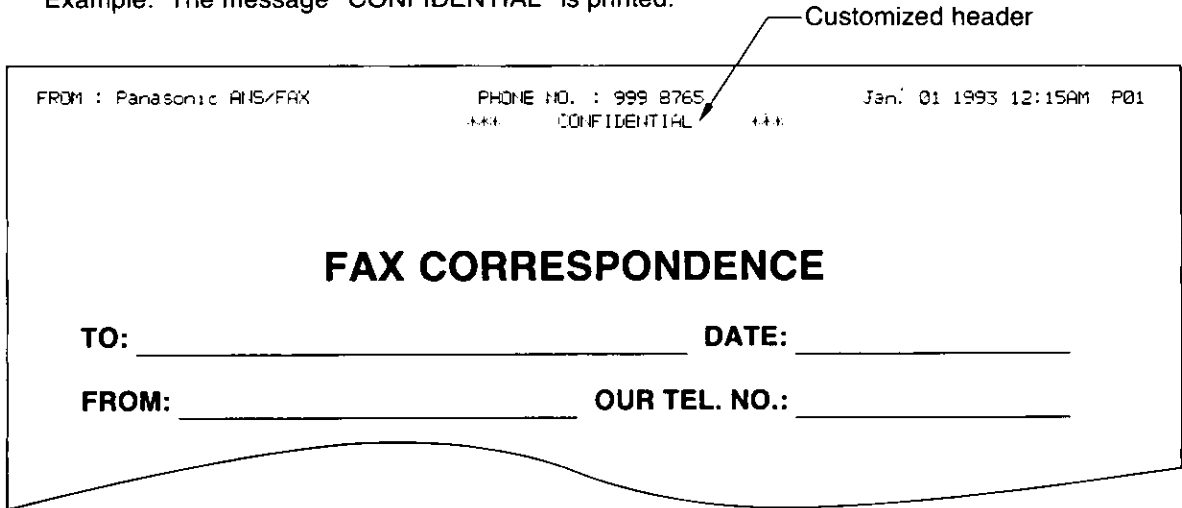

To set a special message:

1

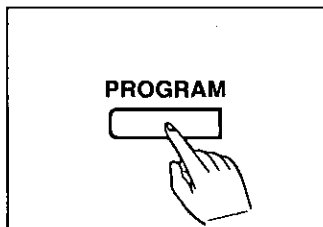

Press the **PROGRAM** button.

The PROGRAM indicator lights.

2

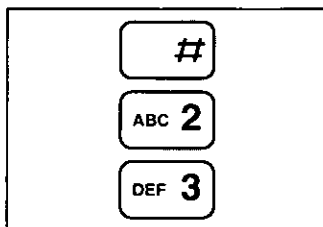

Press #, then press **23**.

The PROGRAM indicator flashes.

3

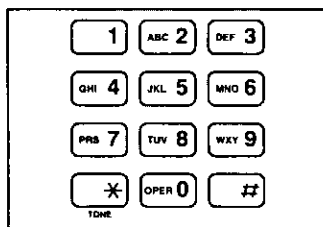

Select the number of the message you desire.

Setting selections are:

- 1: "CONFIDENTIAL" is printed.
- 2: "URGENT REPLY REQUEST" is printed.
- 3: "URGENT PLEASE READ" is printed.
- 4: OFF (deactivate this feature)

(continued)

4

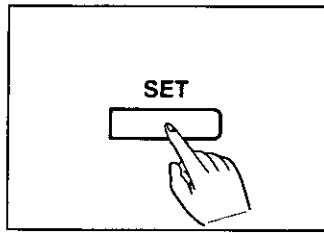

Press the **SET** button to store your selection into memory.

The PROGRAM indicator lights.

5

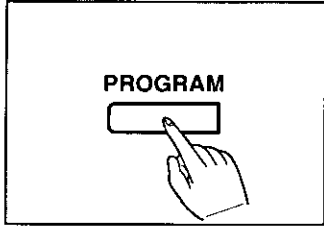

Press the **PROGRAM** button to end the operation.

The PROGRAM indicator goes out.

NOTE:

This feature is automatically turned off after each transmission has been finished.

Operating an Answering Device from a Remote Phone

While you are out, you can listen to any recorded incoming messages or re-record your greeting message using a touch tone telephone.

The following features are available on this unit:

- Playing back newly recorded messages
- Playing back all the recorded messages
- Back space and skip forward
- Recording a marker message
- Resetting the tape for future messages
- Room monitor
- Re-recording the greeting message
- Skipping the greeting message for incoming message recording mode

Before using these features, you must program your unique remote code (REMOTE ANS ID) that lets you access the answering device of your unit.

The REMOTE ANS ID is preset to "111" as a default.
If you wish to change the code, see page 1-33.

Summary of remote control functions

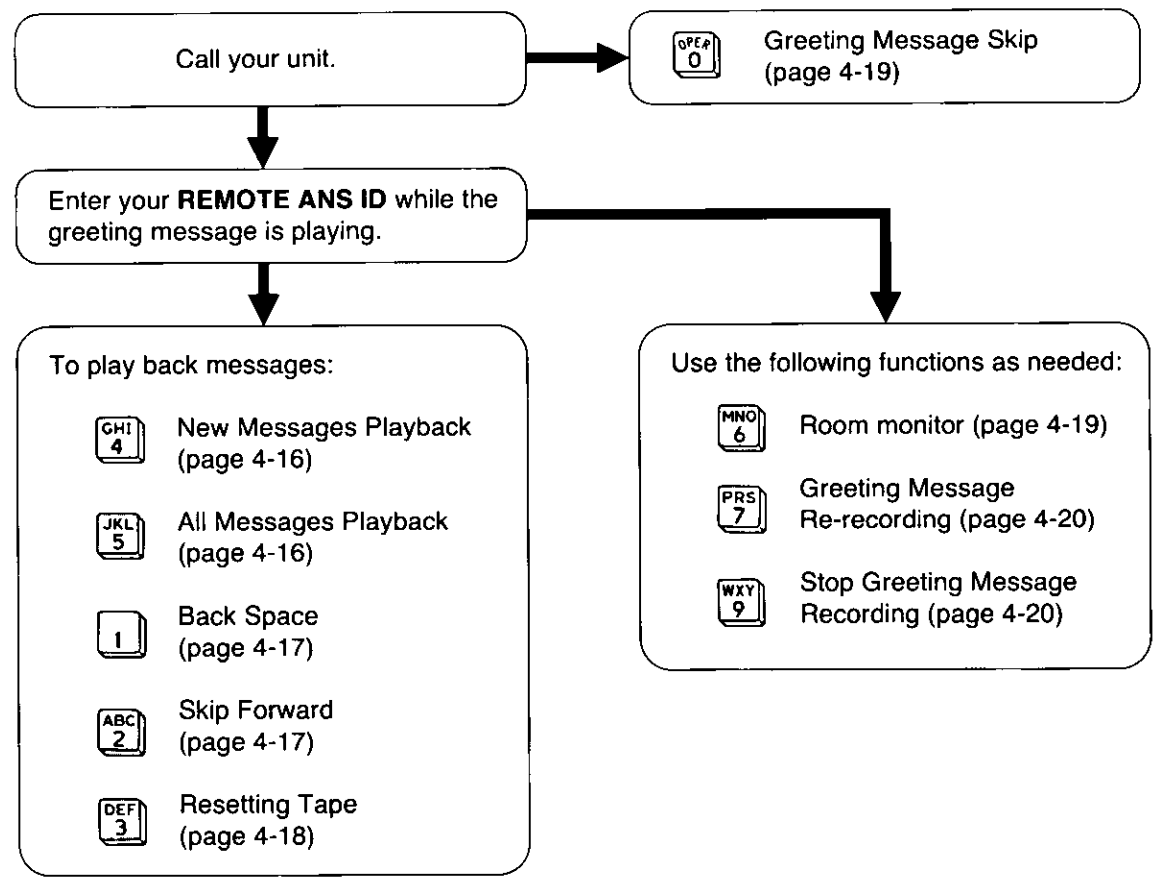

NOTE:

For your convenience, a quick reference card for remote operation is attached in these operating instructions (see pages 6-17 and 6-18).

Playing back newly recorded messages (Memory playback)

It is possible to skip over the recorded messages you have already heard and to play back only new messages.

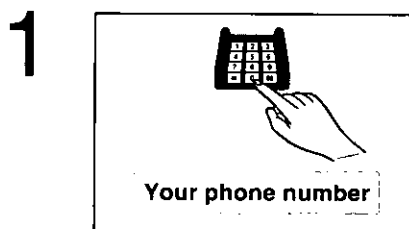

Call your unit.

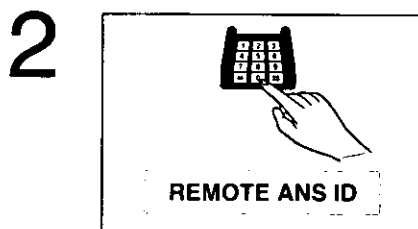

Dial your REMOTE ANS ID while the greeting message is playing.

A long beep and a short beep(s) will sound. Short beep(s) indicate(s) the number of recorded message(s) up to 8 times. Even if 9 or more calls are recorded, a short beep sounds 8 times.

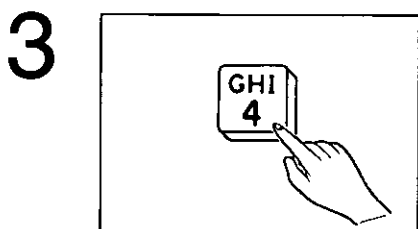

Press 4 immediately after hearing the beeps that indicate the number of recorded messages.

The unit plays back the new messages.

NOTE:

Even during the playback of previously heard messages, you can skip them by pressing 4.

Playing back all messages

You can listen to all the recorded messages from the beginning of the tape.

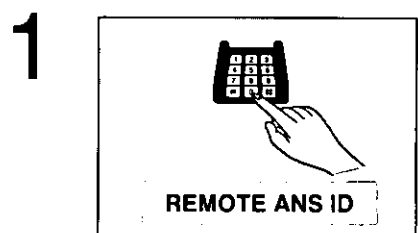

Call your unit then dial your REMOTE ANS ID while the greeting message is playing.

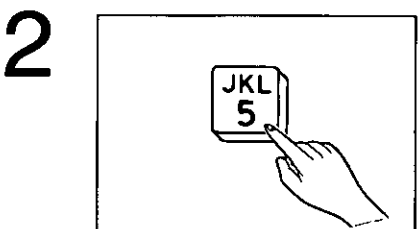

Press 5 within 4 seconds after the short beeps.

The unit will rewind the tape and start to play back all messages.

At the end of the last message, 3 beeps will sound. After hanging up, all the recorded messages are saved and the unit is ready to record further messages.

NOTE:

Even if you do not press 5 in step 2, playback of all messages starts automatically.

Back space and skip forward

While listening to the recorded messages, you can rewind or advance the tape.

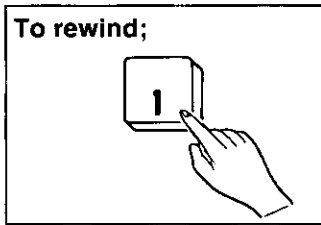

To rewind, press 1.

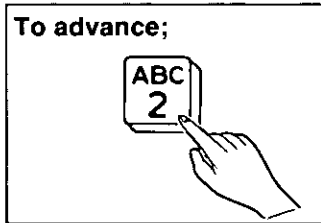

To advance, press 2.

NOTE:

The maximum length of a message that can be rewound or advanced by one press is approximately 15 seconds. You may have to press 1 or 2 several times to rewind or advance the tape to the desired position.

Recording a marker message

After playing back the recorded messages, you can leave an additional message during the same call.

When playback is finished, wait for 3 beeps indicating the end of the last message. Wait about 10 seconds for another 2 beeps indicating that the tape is ready for recording.

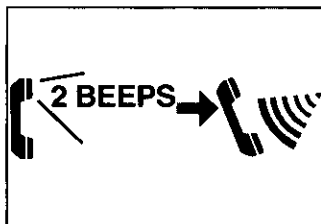
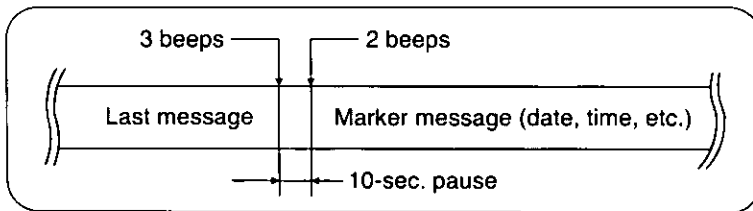

Leave your message after the last 2 beeps.

Hang up when finished. The marker message is recorded after the last message on the tape.

Resetting the tape for future messages

After listening to the recorded messages, you can reset the tape to record future messages from the beginning of the tape.

After all the messages have been played back or even while they are being played;

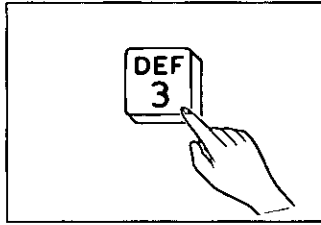

Press 3, then hang up.

The unit rewinds the tape to the beginning. Future messages will be recorded and the previously recorded messages are erased.

If you have used New Messages Playback;

1

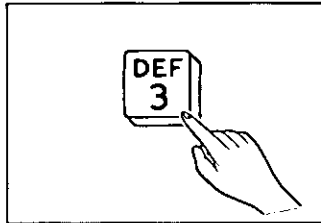

Press 3.

The unit rewinds the tape to the beginning of the newly recorded messages, then beeps.

2

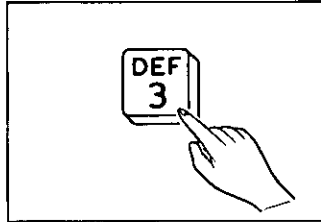

Press 3 again after hearing the beep.

The unit rewinds the tape to the beginning of the previously recorded messages.

If you have reset the tape by mistake;

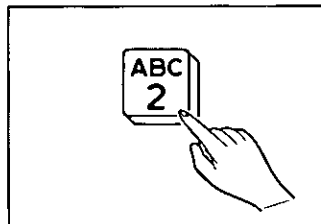

Press 2 after the tape has been reset.

One beep sounds.

The unit advances the tape to the end of the recorded messages.

Room monitor

You can monitor the sound in the room where the unit is installed for about 30 seconds.

1

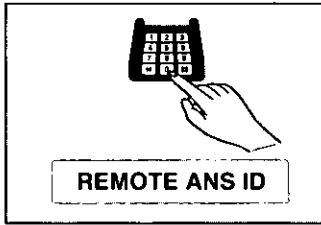

Call your unit, then dial your REMOTE ANS ID while the greeting message is playing.

2

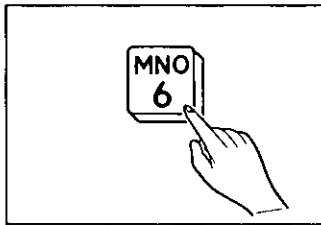

Press 6 after hearing the beeps that indicate the number of recorded messages.

NOTE:

To continue monitoring, press 6 again within 10 seconds after hearing one beep.

Skipping the greeting message for incoming message recording mode

Callers can leave a message on your unit without listening to your greeting message.

1

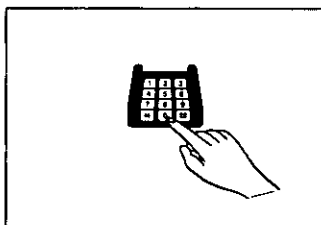

Call your unit.

2

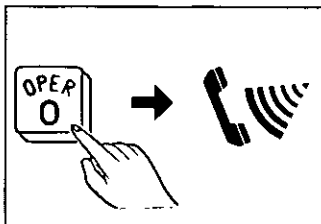

Press 0 while the greeting message is playing.

After hearing a long beep, speak clearly and loudly to leave a message.

Re-recording a greeting message

You can change the content of your greeting message from a remote telephone.

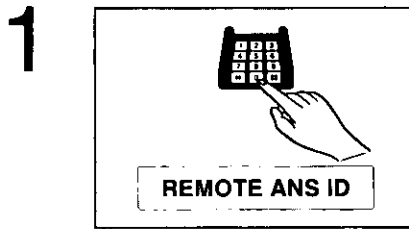

Call your unit, then dial your REMOTE ANS ID while the greeting message is playing.

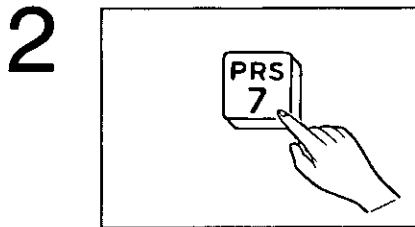

Press 7 to start re-recording after hearing the beeps that indicate the number of recorded messages.

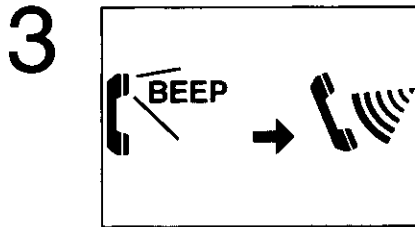

After hearing a long beep, speak clearly and loudly for up to 16 seconds.

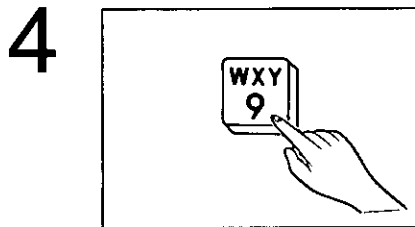

When finished, press 9.

The new greeting message is played to confirm the change.

NOTE:

If you pause for over 2 seconds while recording, the unit beeps and stops the greeting message recording. In this case, repeat from step 2 within 10 seconds.

Call with Privacy Ring

This feature eliminates interruptions caused by unwanted calls. Only callers with a passcode can activate a distinctive tone during the playing of your greeting message to notify you of a priority call.

Entering a unique 3-digit code activates this feature. Issue your code to those callers with priority status. All other calls will be routed to the answering system unless you pick up the handset.

The unit provides PRIVACY RING ID "333" as default setting.
If you wish to change the number, follow the steps on page 4-22.

NOTE:

This feature is effective only in the ANS/FAX mode.

Calling with the privacy ring

Instructions for caller:

1

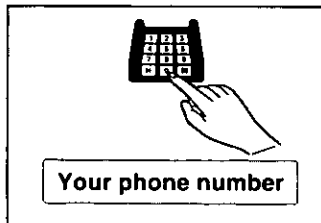

Call the unit with a touch tone telephone.

2

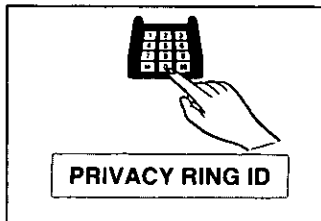

Enter the PRIVACY RING ID during the greeting message or the incoming message recording mode.

NOTES:

- If nobody answers, press 0 to turn on the incoming message recording mode.
- The unit rings with a distinctive tone for 30 seconds and goes to the incoming message recording mode if nobody answers. To repeat this process, enter the PRIVACY RING ID code again during the incoming message recording mode.

Programming the PRIVACY RING ID

You can choose any number of 3 digits except numbers including "0". You should also use a number that is different from the REMOTE ANS ID (see page 1-33).

1

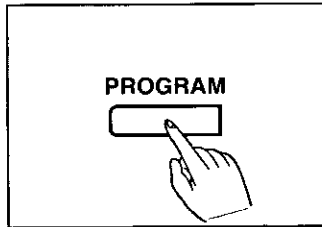

Press the **PROGRAM** button.

The PROGRAM indicator lights.

2

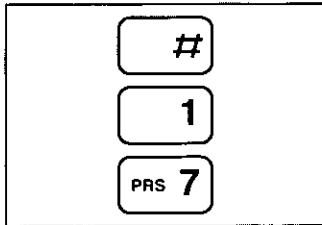

Press #, then press 17.

The PROGRAM indicator flashes.

3

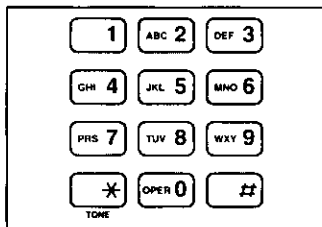

Enter the 3-digit number as the new PRIVACY RING ID.

To correct an error, press the STOP/CLEAR button then repeat from step 2.

4

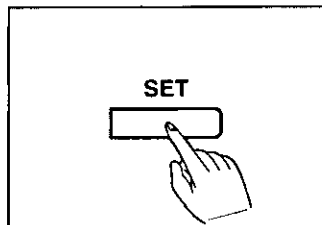

Press the **SET** button to store the program into memory.

The PROGRAM indicator lights.

5

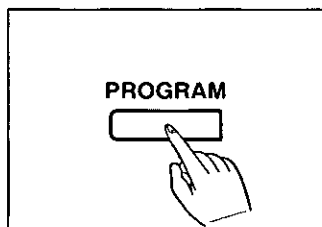

Press the **PROGRAM** button to end the operation.

The PROGRAM indicator goes out.

Setting the Message Alert

When this feature is on, the unit will let you know with an alert if a caller's message has been recorded or not.

When a new message is recorded in the ANS/FAX mode, a slow beep will sound and the indicator will blink. When you hear the beep sound, play back the message(s), the beep sound will stop and the indicator will stop blinking.

To set the message alert:

1

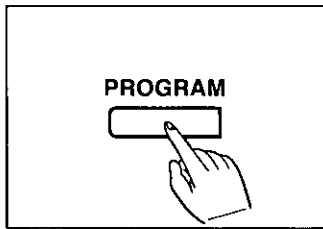

Press the **PROGRAM** button.

The PROGRAM indicator lights.

2

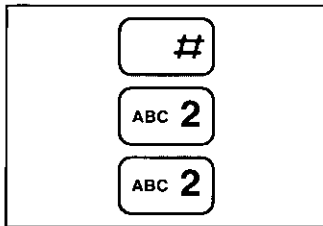

Press #, then press **22**.

The PROGRAM indicator flashes.

3

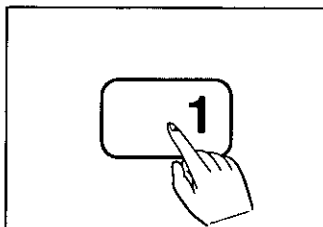

Press 1 to activate this feature.

Setting selections are:

1: ON (activate this feature)

2: OFF (deactivate this feature)

4

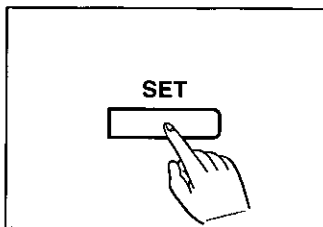

Press the **SET** button to store your selection into memory.

The PROGRAM indicator lights.

5

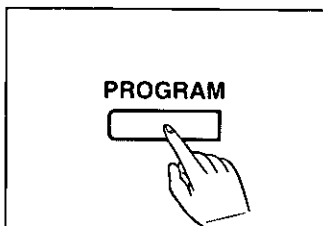

Press the **PROGRAM** button to end the operation.

The PROGRAM indicator goes out.

Voice Contact

Initiating voice contact

While transmitting or receiving a document, you may wish to speak to the other party. If the other party's unit is equipped with a voice contact feature, you can initiate voice contact and notify the other party that you wish to speak after the transmission/reception is completed. The other party's fax will emit a distinctive ring that indicates that a voice conversation is required. This saves the extra expense and time of making a subsequent telephone call to discuss information sent over the fax.

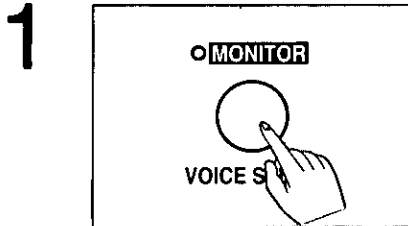

Press the **MONITOR** button or lift the handset while transmitting or receiving the documents.



When the other party answers, start speaking using the handset.

—If you initiate voice contact while transmitting documents, you can speak after all the documents have been transmitted.

—If you initiate voice contact while receiving documents, you can speak after receiving the current page of the documents.

Receiving a request for voice contact

If the other party initiates voice contact during transmission or reception, your unit will emit a distinctive ring after the fax is completed.



When the unit rings, lift the handset and start speaking.

NOTE:

If you do not answer within 10 seconds after hearing several rings indicating the request for voice contact, one of the following occurs:

- When the unit is in the ANS/FAX mode, it plays back your greeting message and records the voice-message on the tape.
- When the unit is in the TEL/FAX mode, the line is disconnected.
- When the unit is in the FAX mode, the line is disconnected.
- When the unit is in the TEL mode, the line is disconnected.

TONE, FLASH and PAUSE Button Usage

TONE button (Temporary tone dialing)

This function is only used when your line has a rotary pulse dial service. Pressing the TONE (*) button allows you to change from pulse to tone mode during a dialing operation and enter special tones and codes to operate the answering device, electronic banking services, call processing services and other special services.

Using the TONE button:

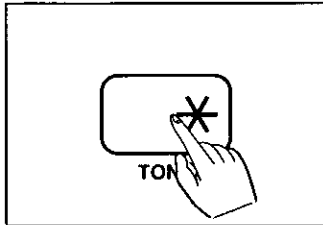

Press the **TONE** (*) button.

When you hang up, the unit automatically returns to pulse mode.

NOTES:

- Store "TONE" in memory as explained on pages 3-2 to 3-5.
- Pressing the TONE button counts as 1 digit while programming.

FLASH button

The FLASH button is used to access some of the features of your host PABX (private automatic branch exchange).

For further details, please contact your local telephone company for information about the availability of these services in your area.

Using the FLASH button:

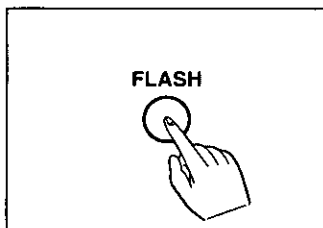

Press the **FLASH** button briefly when required.

NOTES:

- Store "FLASH" in memory as explained on pages 3-2 to 3-5.
- Pressing the FLASH button counts as 1 digit while programming.

PAUSE button

The PAUSE button is used in a dial sequence to access an outside line. Pressing the PAUSE button creates a dialing delay.

Using the PAUSE button:

Example: Line access number 9

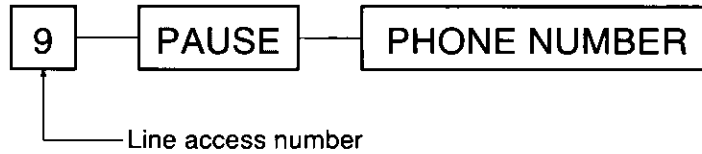

NOTES:

- Store "PAUSE" in memory as explained on pages 3-2 to 3-5.
- Pressing the PAUSE button counts as 1 digit while programming.

Combination dialing

The following combination of dialing methods can be used.

- Manual dialing and automatic dialing
- Pulse and Tone dialing
- Plural memory stations

Other Features

Setting Day/Night Mode

You may wish to use the unit as a telephone and facsimile during the business hours and switch to the answering device during off hours.

With this feature on, the unit automatically switches from the Day mode (TEL/FAX mode) to the Night mode (ANS/FAX mode) at a preprogrammed time without the operator's assistance.

HELPFUL HINT:

When you lose your procedures while programming, press the **HELP** button.

You will be able to print information about how to set.

1

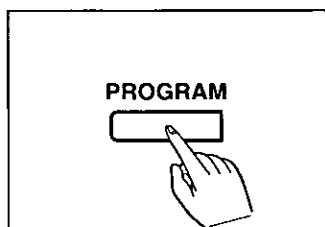

Press the **PROGRAM** button.

The PROGRAM indicator lights.

2

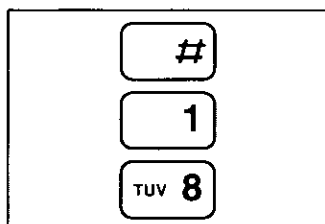

Press #, then press **18**.

The PROGRAM indicator flashes.

3

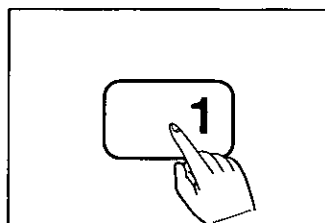

Press **1** to turn on the Day/Night Mode.

Setting selections are:

- 1: ON (activate this feature)
- 2: OFF (deactivate this feature)

4

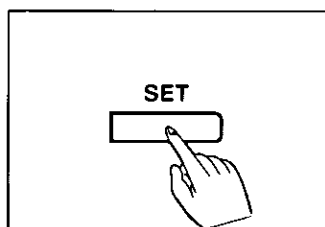

Press the **SET** button.

The current setting is printed out automatically for confirmation.

5

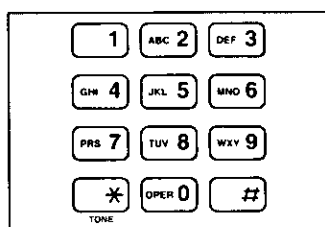

Enter the time at which the Day mode (TEL/FAX mode) starts.

Example: The TEL/FAX mode start time is 8:00AM.
Press 08 and 00.
Press * to select AM mode.
(To select PM mode, press #.)

(continued)

6

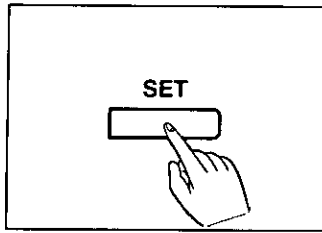

Press the **SET** button.

The result of your setting is printed out automatically for confirmation.

If you wish to correct your programming, press the STOP/CLEAR button then repeat from step 2.

7

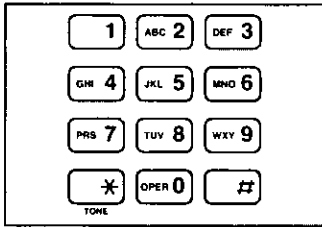

Enter the time at which the unit switches to the Night mode (ANS/FAX mode).

Example: The ANS/FAX mode start time is 5:00PM.
Press 05 and 00.

Press # to select PM mode.

(To select AM mode, press *.)

8

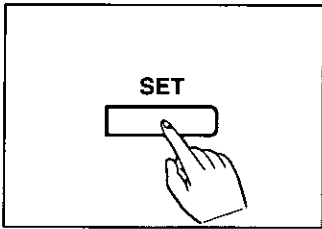

Press the **SET** button.

The PROGRAM indicator lights.

The result of your setting is printed out automatically for confirmation.

If you wish to correct your programming, try again from step 2.

9

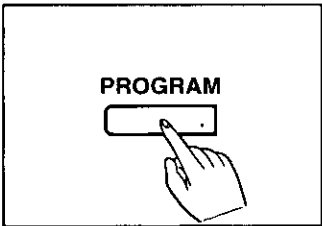

Press the **PROGRAM** button to end the operation.

The PROGRAM indicator goes out.

NOTE:

If you select another receiving mode manually while this feature is on, the unit keeps the receiving mode that you selected until the Day or Night mode starts.

Setting the Silent Fax Recognition Ring

When a voice call is received in the TEL/FAX mode, the unit will ring three times before it switches automatically to the fax. When an automatic fax transmission is received in the TEL/FAX mode, the unit will receive the fax without ringing (we call this "Silent Fax Recognition Ring"). Change the number of rings choosing the number among "3" (three rings) through "8" (eight rings).

The three rings is preset as default.

NOTES:

- This feature is effective only in the TEL/FAX mode.
- Telephone fees are charged to the calling party from the first ring.

To change the ring count:

1

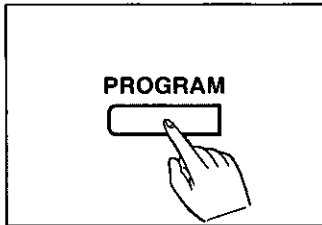

Press the **PROGRAM** button.
The PROGRAM indicator lights.

2

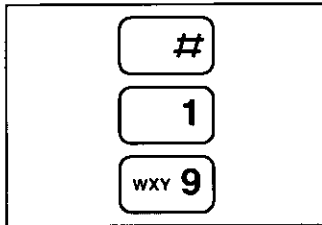

Press #, then press **19**.
The PROGRAM indicator flashes.

3

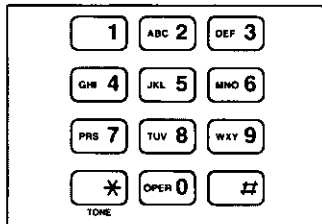

Enter the desired number from 4 to 8.

4

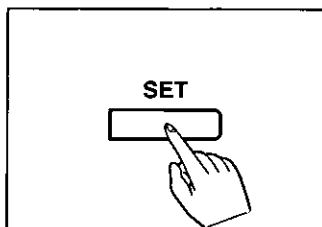

Press the **SET** button to store your selection into memory.
The PROGRAM indicator lights.

5

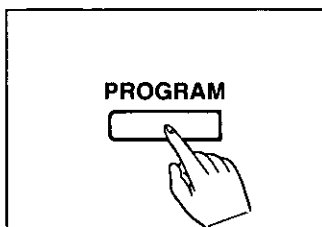

Press the **PROGRAM** button to end the operation.
The PROGRAM indicator goes out.

Resetting the setup features

Use this operation to return the advanced features of #10 through #23 (see page 1-25) to their initial default settings.

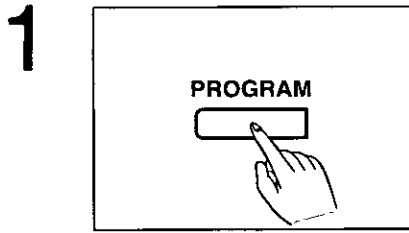

Press the **PROGRAM** button.

The PROGRAM indicator lights.

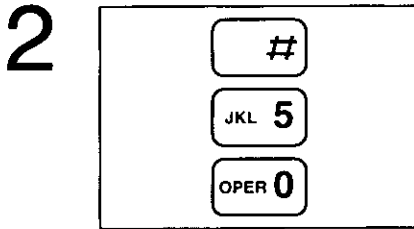

Press #, then press **50**.

The PROGRAM indicator flashes.

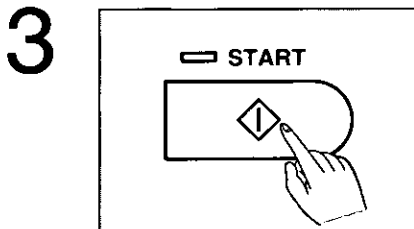

Press the **START** button.

The following message will be printed out.

USER PROGRAMMABLE FUNCTIONS RESET OK? YES: PRESS "START"
 NO : PRESS "STOP/CLEAR"

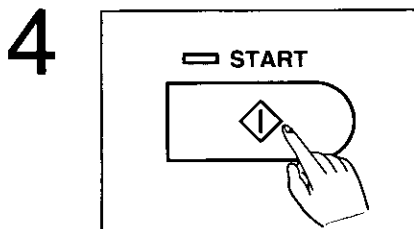

Press the **START** button to return to initial settings.

The following message will be printed out.

USER PROGRAMMABLE FUNCTIONS RESET COMPLETED!

OR

Press the **STOP/CLEAR** button to cancel.

The PROGRAM indicator lights.

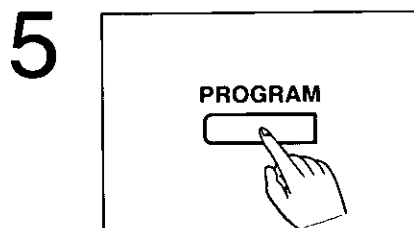

Press the **PROGRAM** button to end the operation.

The PROGRAM indicator goes out.

Chapter 5

Printing Reports and Lists

Table of contents

Activity Report (JOURNAL Report)	5-2
Setting the JOURNAL AUTO PRINT	5-3
Printing a JOURNAL report manually	5-4
List of Stored Phone Numbers (TELEPHONE NUMBER LIST)	5-5
Printing a TELEPHONE NUMBER LIST	5-6
Basic Feature List	5-7
Advanced Feature List	5-8

Activity Report (JOURNAL Report)

You can obtain a record of the last 20 transactions (transmissions and receptions) automatically or manually.

When the JOURNAL AUTO PRINT is set to **AUTO**, the report prints automatically after every 20 transactions. After each 20 transactions, the report clears and the list begins again. It may also be printed on request.

When you set this feature to **MANUAL**, the JOURNAL report data is stored until the memory becomes full. Once the memory is full, the oldest entry in the memory is deleted when a new transaction takes place.

This feature has been preset to **AUTO** as the default.

These reports are useful for keeping records of telephone usage or verifying telephone long distance charges.

Print time: Hour/Minute AM/PM
 Print date: Month/Day/Year
 Jan. 02 1993 10:56AM

```
***** JOURNAL *****
*
*
*
* NO.   OTHER FACSIMILE   START TIME   USAGE TIME   MODE   PAGES   RESULT   CODE
*-----*
* 01   1234567             Jan. 1 11:28AM 01'20      TX     02     OK       (00)
* 02   9998765             Jan. 1 11:52AM 00'56      TX     01     OK       (00)
* 03   <<< G3 >>>         Jan. 1 11:28AM 00'32      RX     01     OK       (00)
* 04   5556677             Jan. 1 12:19PM 01'48      TX     03     OK       (00)
* 05   +987 1234           Jan. 1 12:35PM 01'45      RX     03     OK       (00)
* 06   <S01>                Jan. 1 1:14PM  02'40      TX     05     OK       (00)
* 07   7776543             Jan. 1 1:27PM  01'03      TX     01     OK       (00)
* 08   4445566             Jan. 1 2:46PM  01'18      TX     02     OK       (00)
* 09   <A0>                 Jan. 1 3:17PM  00'35      TX     00     PRESSED THE STOP KEY (A2)
* 10   <<< G3 >>>         Jan. 1 3:19PM  01'21      RX     03     OK       (00)
* 11   661234              Jan. 1 3:38PM  02'25      TX     04     OK       (00)
* 12   <S06>                Jan. 1 4:20PM  01'02      TX     01     OK       (00)
* 13   +1177              Jan. 1 4:20PM  02'18      TX     04     OK       (00)
* 14   <S06>                Jan. 1 4:20PM  02'18      TX     04     OK       (00)
* 15   <S06>                Jan. 1 4:20PM  02'18      TX     04     OK       (00)
* 16   <S06>                Jan. 1 4:20PM  02'18      TX     04     OK       (00)
* 17   <S06>                Jan. 1 4:20PM  02'18      TX     04     OK       (00)
* 18   <S06>                Jan. 1 4:20PM  02'18      TX     04     OK       (00)
* 19   <S06>                Jan. 1 4:20PM  02'18      TX     04     OK       (00)
* 20   9996675             Jan. 2 10:55AM 00'58      TX     01     OK       (00)
*
*****
```

Dialed number or other party's name
 Length of communication: Minutes/Seconds
 Number of pages received or transmitted successfully
 Error code (for the service center only)

Communication number (up to 20)
 Communication start time
 Transaction mode: TX...Transmission, RX...Reception, POL.RX...Polling
 Communication result

Explanation of communication result

- OK: Successful communication
- PRESSED THE STOP KEY: The fax communication was interrupted since the STOP/CLEAR button was pressed.
- DOCUMENT JAMMED: A document jammed.
- NO DOCUMENT: The document was not fed into the unit properly.
- PRINTER OVERHEATED: Printing head was overheated.
- PAPER OUT: The unit is out of recording paper.
- THE COVER WAS OPENED: The front lid or back lid was opened.
- COMMUNICATION ERROR: Transmission or reception error.
- PASSCODE FAILED: Passcode communication failed.
- NO RESPONSE: Receiving unit is busy or out of recording paper.
- PAPER JAMMED: The recording paper was jammed.

NOTE:
 If the printed time and date on the report are not accurate, reprogram them by following the instructions on pages 1-18 and 1-19.

Printing Reports and Lists

Setting the JOURNAL AUTO PRINT

HELPFUL HINT:

When you lose your procedures while programming, press the **HELP** button. You will be able to print information about how to set.

1

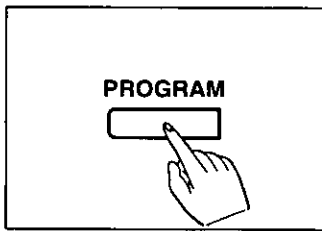

Press the **PROGRAM** button.

The PROGRAM indicator lights.

2

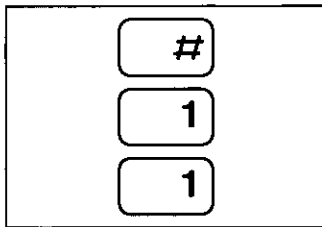

Press #, then press 11.

The PROGRAM indicator flashes.

3

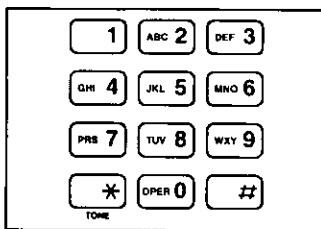

Press the number of the selection you desire.

Setting selections are:

- 1: AUTO (Prints a report every 20 transactions automatically.)
- 2: MANUAL

4

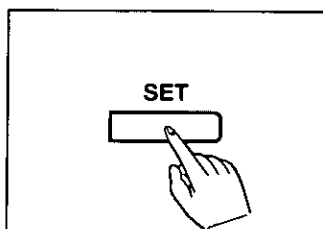

Press the **SET** button to store your selection into memory.

The PROGRAM indicator lights.

5

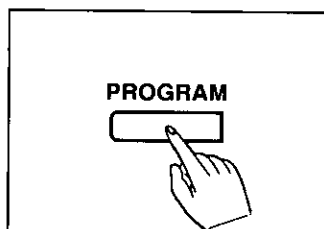

Press the **PROGRAM** button to end the operation.

The PROGRAM indicator goes out.

Printing a JOURNAL report manually

You can print a report of the current JOURNAL upon request. This will not clear the report which will continue until 20 transactions are completed.

1

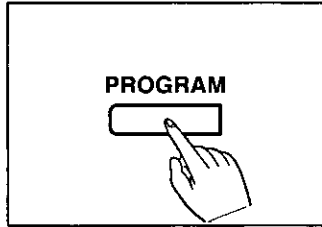

Press the **PROGRAM** button.

The PROGRAM indicator lights.

2

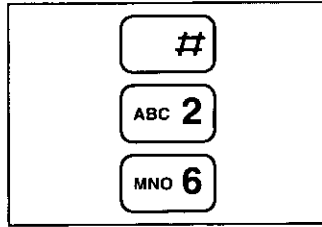

Press #, then press **26**.

The PROGRAM indicator flashes.

3

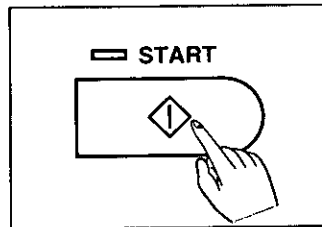

Press the **START** button to obtain a report.

The unit will start printing.

If there have been no transactions, no JOURNAL is printed.

When finished, the PROGRAM indicator goes out.

List of Stored Phone Numbers (TELEPHONE NUMBER LIST)

You can print a list of the numbers programmed for one touch dialing and speed dialing. Use this feature to confirm that you have correctly stored phone numbers.

Sample of TELEPHONE NUMBER LIST

```

***** TELEPHONE NUMBER LIST *****
*
*                               << STATION KEY LIST >>                               *
*-----*
*      PHONE NUMBER                PHONE NUMBER                *
*      01 T092-123-4567            07 R999-1234                *
*      02 T83R555-1234            08 R[                    ] *
*      03 T012-999-8877            09                          *
*      04 T83P4567                 10                          *
*      05 T987-6543                 11                          *
*      06                          12                          *
*
*                               << AUTO KEY LIST >>                               *
*-----*
*      PHONE NUMBER                PHONE NUMBER                *
*      0 T111-2233                 5 T222-3344                *
*      1 R765-4321                 6 T9P092-555-6677         *
*      2 T345F6789                 7                          *
*      3 R092[                    ] 8                          *
*      4                          9                          *
*
*                               Secret phone number                               *
*****

```

Codes in each phone number:

- T: Shows that you have entered the telephone number in the TONE dialing mode.
- R: Shows that you have entered the telephone number in the PULSE (rotary) dialing mode.
- P: Shows that you have entered PAUSE.
- F: Shows that you have entered FLASH.

Printing a TELEPHONE NUMBER LIST

1

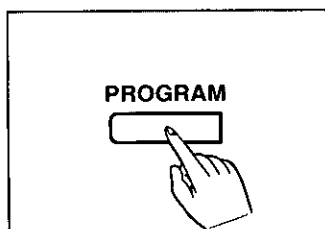

Press the **PROGRAM** button.

The PROGRAM indicator lights.

2

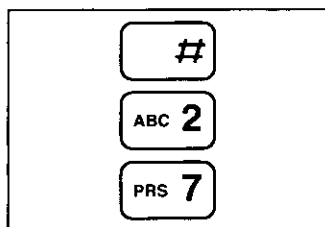

Press #, then press **27**.

The PROGRAM indicator flashes.

3

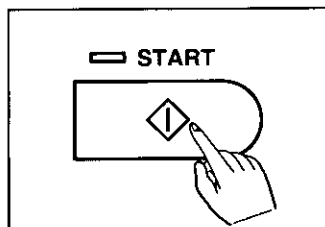

Press the **START** button.

The unit will start printing.

When finished, the PROGRAM indicator goes out.

Basic Feature List

Sample of Basic Feature List

```

***** < BASIC FEATURE LIST > *****
*
*      #01 SET DATE                = Jan. 01 1993 12:00AM
*      #02 YOUR LOGO (I.E. COMPANY OR INDIVIDUAL NAME)
*                                     = Panasonic ANS/FAX
*      #03 YOUR TELEPHONE NUMBER    =
*      #04 PRINT TRANSMISSION REPORT = ERROR      [1=ON 2=ERROR 3=OFF]
*      #05 ANS/FAX RING COUNT       = 1          [1...4 0=TOLL SAVER *=RINGER OFF]
*      #06 FAX RING COUNT            = 1          [1...4]
*      #07 RECORDING TIME FOR ANS    = VDX        [1=VDX 2=1M[N]
*      #08 REMOTE ANS ID              = 111
*      #99 PRINT ADVANCED FEATURE LIST
*
*
*****

```

Code	Functions	Settings [selections]

To obtain a Basic Feature List:

1

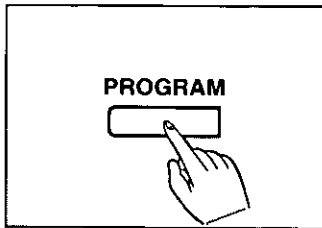

Press the **PROGRAM** button.

The PROGRAM indicator lights.

2

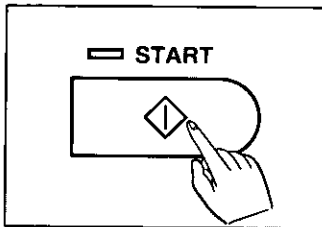

Press the **START** button.

The unit will start printing.

When finished, the PROGRAM indicator goes out.

Advanced Feature List

Sample of Advanced Feature List

Code	Functions	Settings [selections]
***** < ADVANCED FEATURE LIST > *****		
#10	LOGO POSITION	= OUT [1=OUT 2=IN 3=OFF]
#11	JOURNAL AUTO PRINT	= AUTO [1=AUTO 2=MANUAL]
#12	MAIN PASSCODE	= 0000
#13	TX PASSCODE CHECK	= OFF [1=ON 2=OFF]
#14	RX PASSCODE CHECK	= OFF [1=ON 2=OFF]
#15	POLLING PASSWORD	= 0000
#17	PRIVACY RING ID	= 333
#18	DAY/NIGHT MODE	= OFF [1=ON 2=OFF]
	DAY MODE START TIME	= 12:00AM
	NIGHT MODE START TIME	= 12:00AM
#19	SILENT FAX RECOGNITION RING	= 3 [3...8]
#20	REMOTE FAX ACTIVATION CODE	= **
#22	MESSAGE ALERT	= OFF [1=ON 2=OFF]
#23	CUSTOMIZED HEADER	= OFF [1=A 2=B 3=C 4=OFF]
	A= *** CONFIDENTIAL ***	
	B= *** URGENT REPLY REQUEST ***	
	C= *** URGENT PLEASE READ ***	
#26	PRINT JOURNAL	
#27	PRINT TEL LIST	
#28	PRINTER TEST	
#50	SET DEFAULT (#10 TO #23)	
#9200*	(SERVICE DATA SET UP)	

This code is only for a service center.

To obtain an Advanced Feature List:

1

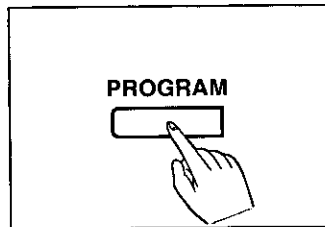

Press the **PROGRAM** button.

The PROGRAM indicator lights.

2

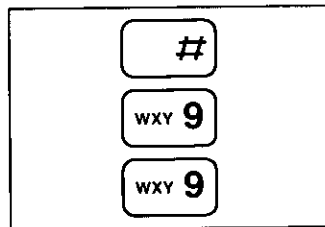

Press #, then press **99**.

The PROGRAM indicator flashes.

3

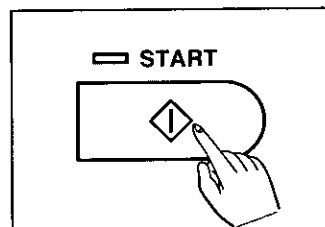

Press the **START** button.

The unit will start printing.

When finished, the PROGRAM indicator goes out.

Chapter 6

General Information

Table of contents

Troubleshooting	6-2
General corrective measures	6-2
Clearing a document jam	6-5
Clearing a recording paper jam	6-6
Maintenance	6-8
Cleaning the microcassette compartment	6-8
Cleaning the document feeder unit	6-9
Cleaning the thermal head	6-9
Printing a test pattern	6-10
Accessory Order Information	6-11
Specifications	6-11
Index	6-12

Troubleshooting

General corrective measures

GENERAL

PROBLEM	CAUSE & REMEDY
I cannot transmit or receive a document or cannot talk.	The line cords are connected incorrectly or not connected. —Confirm the connections (see page 1-9).
The unit does not operate properly.	—Turn the POWER switch off, then turn it on again (see page 1-15).
The ALARM indicator lights.	The BACK LID OPEN cover of the unit is open. —Close it firmly.
The unit does not ring.	The RINGER volume selector is set to the OFF position. —Set the RINGER volume selector to the HIGH or LOW position (see page 1-14).

TRANSMISSION

PROBLEM	CAUSE & REMEDY
The ALARM indicator flashes after transmission.	A transmission error has occurred. —Try again (see page 2-4).
The ALARM indicator lights during transmission.	A document more than 600 mm (23 ⁵ / ₈ ") is being transmitted. —Divide the document so that the length can be shorter than 600 mm (23 ⁵ / ₈ ") (see page 2-2). A document causes a jam. —Remove it, then try again (see page 6-5). The unit has been connected to a line that has special telephone services, such as call waiting. —Connect the unit to a line that does not have such services.
The other party complains that letters on the document are distorted.	If your line has special telephone services such as call waiting, the service may have been activated during the fax reception. —Connect the unit to a line that does not have such services. Another telephone connected to the same line as your unit is connected is hung off. —Hang up and try again.
The other party complains that a dirty pattern or black lines appear on the received documents.	The glass and rollers inside the document feeder unit are dirty. —Clean them (see page 6-9).
The unit does not feed the document properly.	The rollers inside the unit are dirty. —Clean them (see page 6-9).

RECEIVING

PROBLEM	CAUSE & REMEDY
The ALARM indicator lights during copying or receiving.	The recording paper causes a jam. —Remove it (see page 6-6).
Unable to receive documents.	The recording paper is not installed. —Install the recording paper (see pages 1-12 and 1-13).
Unable to receive documents automatically.	The receive mode of the unit is set to the TEL mode. —Operate the manual reception (see page 2-6) or set the receive mode to ANS/FAX, TEL/FAX or FAX mode (see pages 2-7 and 2-8). Your greeting message may be too long. —Shorten your greeting message (see pages 1-16 and 1-17) or ask the other party to press “*” (ASTERISK) then start to transmit a document. —Set the number of rings to answer to “1” (see pages 1-29 to 1-31).
Recording image is faint and I cannot read it well.	The sender transmitted a faint document. —Request the sender to transmit a clearer copy of the document.
The START indicator flashes for about 40 seconds after the unit receives a call automatically, but nothing is recorded.	—The caller hangs up during or immediately after your greeting message plays. This may occur if the disconnected signal is not transmitted from the telephone company’s central office.
Problems when receiving international facsimiles.	Your greeting message may be too long. —Shorten your greeting message to 10 seconds or less (see pages 1-16 and 1-17). The RX SPEED may need to be set to 4800 bps. —Call your service center (see page 6-19).
Unable to retrieve a document using the polling function.	Your polling password does not correspond to that of the other unit. —Program the correct password (see page 4-4). —The other unit does not provide polled function.
Received or copied image is distorted.	The thermal head is dirty. —Clean it with a cloth moistened with isopropyl rubbing alcohol (see page 6-9).

ANSWERING DEVICE & TELEPHONE

PROBLEM	CAUSE & REMEDY
The CALLS indicator flashes slowly.	There has been a power failure. —Confirm whether voice-messages are recorded on the tape or not (see pages 2-11 and 2-12). The microcassette tape was not rewound when the unit was turned on. —Rewind the tape (see page 2-10).
The unit has been set to the ANS/FAX mode, but no voice-messages have been recorded.	The tape is not installed properly or it is broken (cut, worn out or twisted). —Install the tape properly or replace it with a new one (see page 1-11).
When the tape is played, the sound level is low or nothing can be heard.	The speaker volume is low. —Raise the sound level using the VOLUME control. The head in the cassette deck compartment is dirty. —Clean it (see page 6-8).
I have played back all the recorded messages, and I want to record the next call after the last message.	—Leave the unit as it is after hearing the messages.
I cannot retrieve recorded messages from a remote phone.	—Make sure that you use your REMOTE ANS ID number correctly. When you use your REMOTE ANS ID number, press the buttons firmly.
Some voice-messages have not been fully recorded.	The calling party control (CPC) should be set to "B". —Call your service center (see page 6-19).
When a caller hangs up after leaving a message, the tape does not stop.	VOX TIME should be set to 4 seconds. —Call your service center (see page 6-19).

Clearing a document jam

If an original document becomes jammed in the document feeder unit, the ALARM indicator lights and a long beep is heard. Remove the jammed document by following steps below.

1

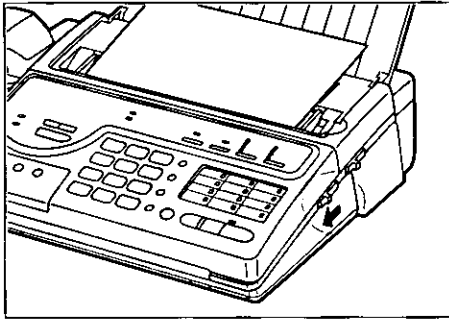

Slide the **FRONT LID OPEN** lever forward to open the document feeder unit.

2

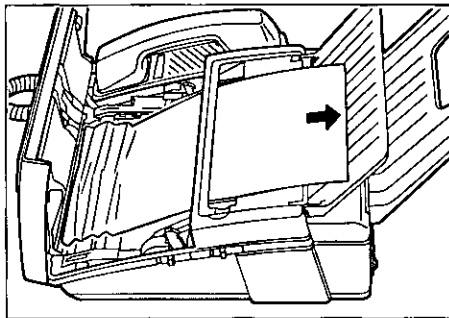

Remove the jammed document carefully.

3

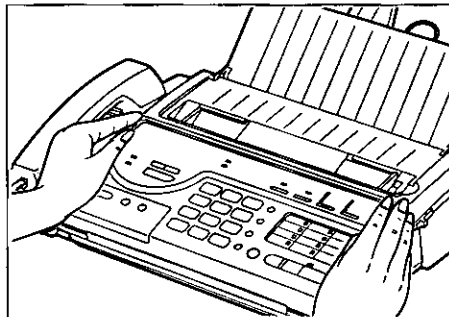

Then close the document feeder unit carefully by pushing down on both ends gently.

Clearing a recording paper jam

When the unit does not eject a recording paper during receiving, the recording paper has jammed. Remove the jammed paper by following the steps below.

1

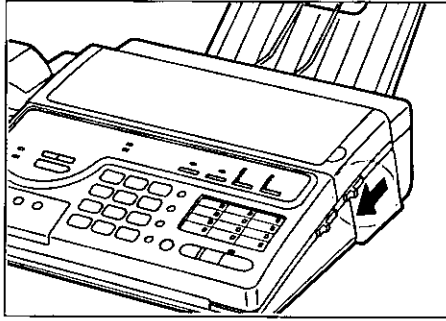

Slide the **BACK LID OPEN** lever forward to open the paper compartment cover.

2

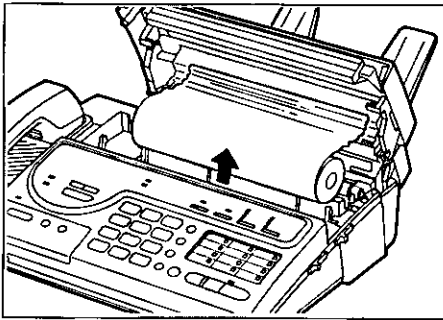

Remove the jammed paper.

3

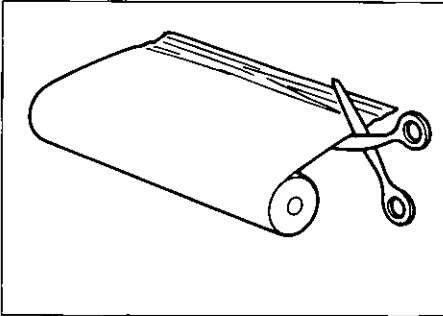

Cut off the wrinkled portion.

4

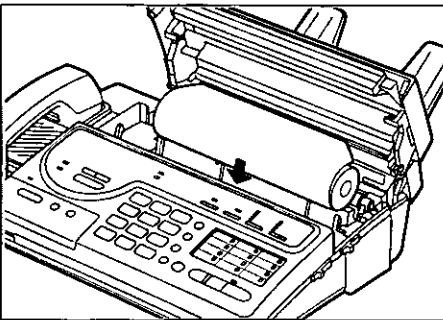

Replace the recording paper roll.

Make sure that the shiny side of the paper is facing up and that there is no slack in the paper roll.

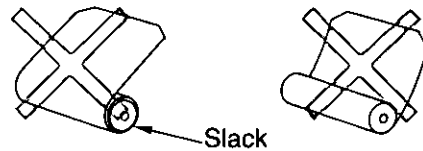

5

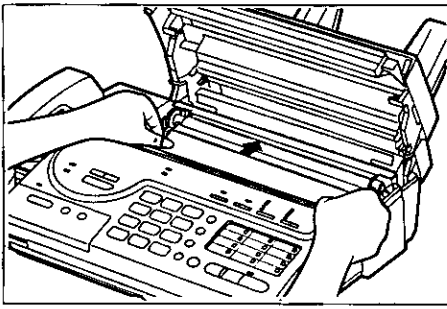

Then insert its leading edge between the upper and lower guide plates and pull the paper a few centimeters (one or two inches) out of the unit.

If the recording paper cannot be inserted; Close the recording paper compartment cover to reset the paper cutter, then open it by sliding the **BACK LID OPEN** lever and insert the paper again.

6

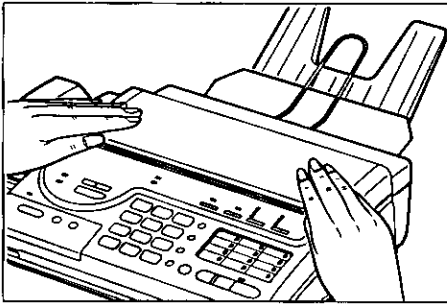

Close the paper compartment cover carefully by pushing down on both ends gently.

NOTE:

When re-installing the KX-A101 or a recording paper with 1/2 inch core, remember to fix the paper roll holders to the recording paper (see page 1-13).

Maintenance

Be sure that the AC plug is disconnected from the outlet before performing any maintenance.

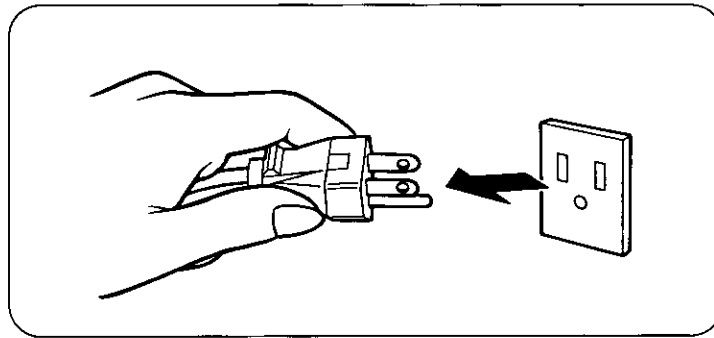

Cleaning the microcassette compartment

Dirt and residue from the tape may adhere to the head and capstan, causing distortion. Clean these parts periodically in the manner described below for the best sound quality.

1. Open the cassette compartment cover.
2. Remove the microcassette tape.
3. Clean the head surfaces, pinch roller and capstan with a cotton swab.
If these surfaces are extremely dirty, wipe them with a cotton swab dampened with isopropyl rubbing alcohol, then wipe them with a dry soft cloth.

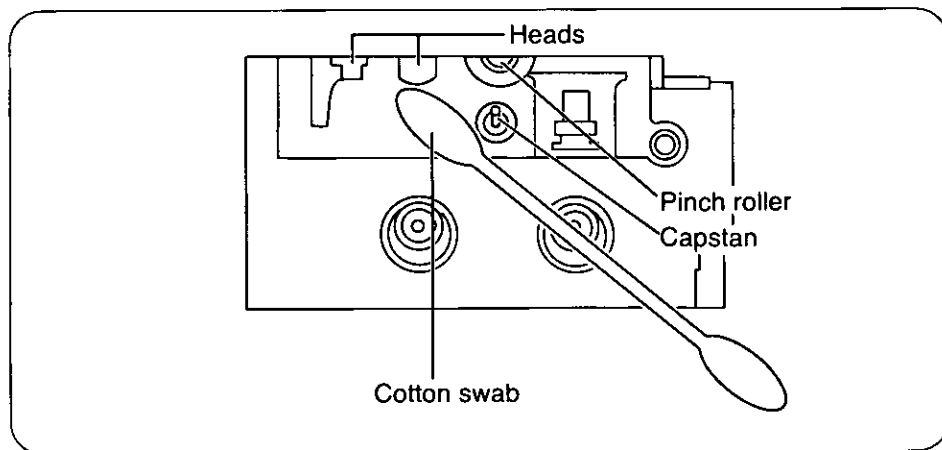

NOTES:

- Do not bring magnetic or metal objects, such as a screwdriver, near the head assembly, as such objects could magnetize the heads.
- Do not oil any part of the unit.

Cleaning the document feeder unit

Clean the inside of the document feeder unit by following the steps below;

- when the unit does not feed the document properly.
- when a dirty pattern or black bands appear on a copied or transmitted document.

1. Turn the **POWER** switch to the “o” (OFF) position and open the document feeder unit.
2. Clean the rubber and the paper rollers rotating them with a cloth moistened with isopropyl rubbing alcohol, then dry thoroughly to prevent paper jams.
3. Clean the glass and the white plate with a dry soft cloth.

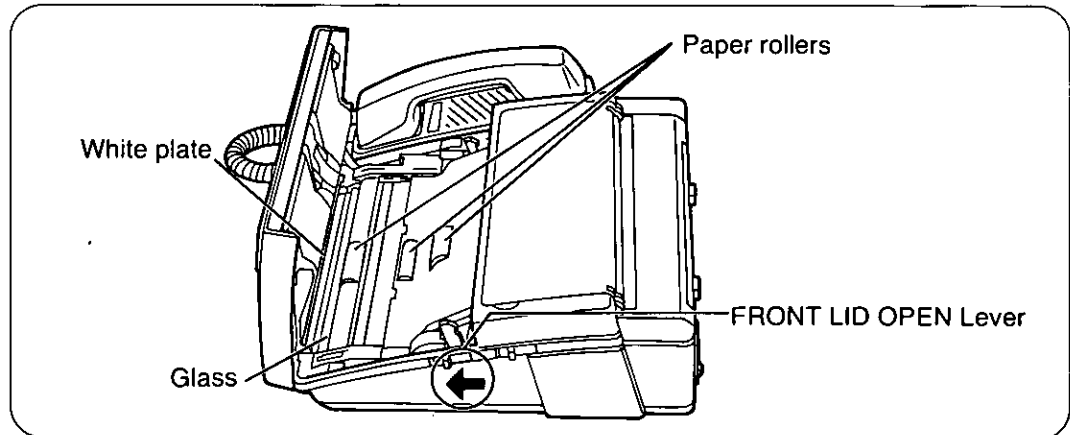

4. Close the document feeder unit and turn the **POWER** switch to the “I” (ON) position.

Cleaning the thermal head

If a dirty pattern or black bands appear on a copied or received document, clean the thermal head inside the recording paper unit by following the steps below.

1. Turn the **POWER** switch to the “o” (OFF) position and open the paper compartment cover.
2. Remove the recording paper from the unit.
3. Clean the thermal head with a cloth moistened with isopropyl rubbing alcohol, then dry thoroughly.

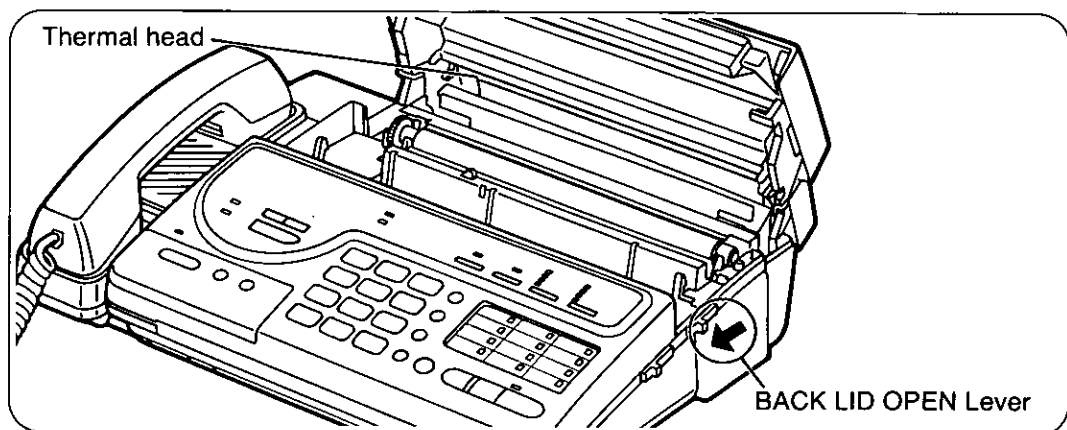

4. Close the paper compartment cover and turn the **POWER** switch to the “I” (ON) position.

NOTES:

- To prevent malfunction due to static electricity, do not use a dry cloth and do not touch the thermal head with your finger directly.
- When finished, confirm the print quality by printing the test pattern (see page 6-10).

Printing a test pattern

You can check the print quality of your unit by printing the test pattern.
If the test pattern has any blurred points or lines or a dirty pattern, please clean the thermal head following the instructions on page 6-9.

To obtain the test pattern, follow the steps below.

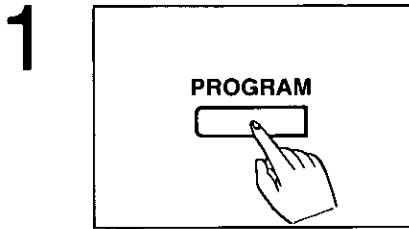

Press the **PROGRAM** button.

The **PROGRAM** indicator lights.

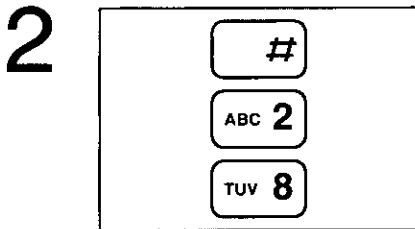

Press #, then press **28**.

The **PROGRAM** indicator flashes.

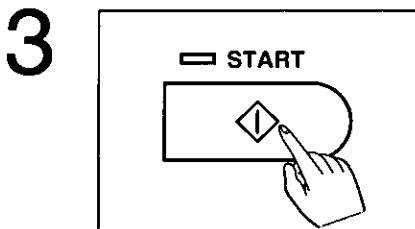

Press the **START** button.

The unit prints the pattern as shown below.

The **PROGRAM** indicator lights.

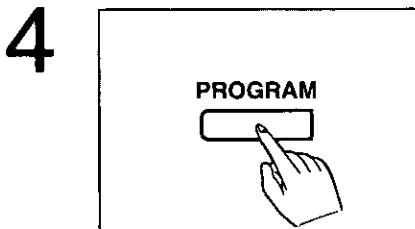

Press the **PROGRAM** button to end the operation.

The **PROGRAM** indicator goes out.

Sample of test pattern:

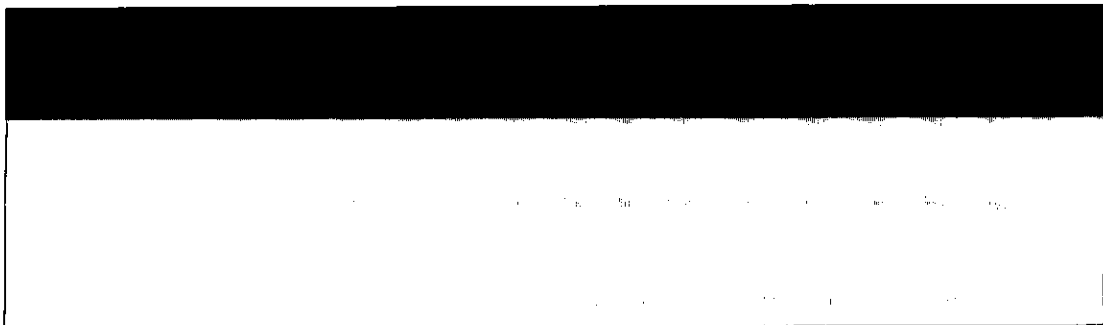

Accessory Order Information

Replacement parts and accessories are available through your local authorized parts distributor. For the authorized distributor in your area, call toll free: 1-800-332-5368.

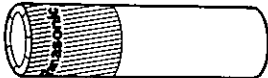
Parts No.	Picture	Description	Comment
MC-30 MC-60		Microcassette Tape	For replacement
KX-A101 KX-A106		Recording Paper 216 mm x 30 m roll (8 1/2" x 98' roll) KX-A101: 1/2 inch core KX-A106: 1 inch core	For supplement

Specifications

Type:	Desktop
Applicable Lines:	Public Switched Telephone Network
Document Size:	Max. 216 mm (8 1/2") in width, Max. 600 mm (23 5/8") in length
Effective Scanning Width:	Max. 208 mm (8 3/16")
Printing Paper Size:	216 mm (letter) x 30 m roll (8 1/2" x 98' roll)
Effective Printing Width:	208 mm (8 3/16")
Transmission Time*:	Approx. 30 sec/page (G3 Normal mode) Approx. 17 sec/page (Original mode)
Scanning Density:	Horizontal 8 pels/mm (203 pels/inch) Vertical 3.85 lines/mm (98 lines/inch) Standard 7.7 lines/mm (196 lines/inch) Fine/Halftone 15.4 lines/mm (392 lines/inch) Superfine
Scanner Type:	CCD image sensor
Printer Type:	Thermal printing
Data Compression System:	Modified Huffman (MH)
Modem Speed:	9600/7200/4800/2400 bps; Automatic Fallback
Automatic Document Feeder:	Max. 10 sheets
Temperature Range:	5°–35°C (41°–95°F)
Humidity Range:	45%–85%
Dimensions (H x W x D):	107 x 379 x 297 mm (4 1/4" x 14 15/16" x 11 3/4")
Weight:	5.6 kg (12.35 lbs)
Power Consumption:	Approx. 50 W
Power Supply:	AC 120 V, 60 Hz

*Transmission Time: Transmission times apply to text data using CCITT No. 1 test chart, between same machine models at maximum modem speed. Transmission times vary in actual usage.

Index

- A**
- AC Jack 1-3
 - AC Outlet 1-9
 - AC Power Cord 1-8
 - Accessories 1-8
 - Activity Report 5-2
 - Advanced Feature List 1-25, 5-8
 - ALARM Indicator 1-5, 1-15
 - ALL MESSAGES Button 1-6, 2-10, 2-12
 - Answering device control panel 1-2
 - ANS/FAX mode 1-23
 - Receiving a document in 2-7
 - ANS/FAX RING COUNT 1-24
 - Selecting 1-29
 - AUTO Button 1-5, 3-2, 3-4
 - Automatic dialer 3-7
 - Making Voice Calls Using 3-8
 - Transmitting Documents Using 3-7
 - Automatic redialing feature 2-5, 3-7
- B**
- BACK LID OPEN Lever 1-2, 1-12, 6-6, 6-9
 - Back space 4-15
 - Basic Feature List 1-24, 5-7
- C**
- CALLS Indicator 1-5, 2-10
 - Cassette Compartment 1-3
 - Character Code Table 1-21
 - CHECK Button 1-6, 1-16, 1-17, 2-10
 - Cleaning
 - Document feeder unit 6-9
 - Microcassette compartment 6-8
 - Thermal head 6-9
 - Combination dialing 4-26
 - Copy
 - Making 2-9
 - COPY Button 1-6
 - Customized Header 1-25
 - Setting 4-13, 4-14
- D**
- DAY/NIGHT MODE 1-25
 - Setting 4-27, 4-28
 - DIALING MODE Selector 1-3, 1-14
 - Setting 1-14
 - Direct Call Station Keys 1-6, 3-2
 - Diverter 1-8
 - Installing 1-10
 - Document 2-2
 - Acceptable 2-2
 - Clearing jam of 6-5
 - Loading 2-3
 - Receiving 2-6, 2-7, 2-8
 - Transmitting 2-4, 3-7
 - You cannot send 2-2
 - Document Feeder Tray 1-2
- F**
- FAX mode 1-23
 - Receiving a document in 2-8
 - FAX RING COUNT 1-24
 - Selecting 1-31
 - FF (Fast Forward) Button 1-6, 2-10
 - FLASH Button 1-5, 4-25
 - FRONT LID OPEN Lever 1-2, 6-9
- G**
- Greeting Message 1-16
 - Checking 1-17
 - Recording 1-17
 - Re-recording 4-20
 - Skipping for incoming message recording mode 4-19
- H**
- Handset 1-8, 1-9
 - Handset cord 1-8, 1-9
 - HELP Button 1-5
 - Using 1-34
 - HELP Function 1-34
 - HYPHEN Key 3-2, 3-3, 3-4
- I**
- ICM ERASE Button 1-6, 2-10
 - Incoming message 2-11
 - Playing back all messages 2-12, 4-16
 - Playing back newly recorded messages 2-11, 4-16
 - Recording where you want to save 2-12
 - IN USE Indicator 1-5
- J**
- JOURNAL AUTO PRINT 1-25
 - Setting 5-3
 - JOURNAL Report 5-2
 - Printing 5-4
- L**
- LIGHT ORIGINAL 2-3
 - Button and Indicator 1-5
 - LINE Jack 1-3
 - Connect to 1-9
 - List of Stored Phone Numbers 5-5
 - Sample of 5-5
 - Listing directory card 3-2
 - LOGO POSITION 1-25
 - Setting 4-12

M		FAX mode	1-23, 2-8
MAIN PASSCODE	1-25	TEL mode	1-23
Main Passcode	4-7	TEL/FAX mode	1-23, 2-8
Programming	4-7	RECEIVE MODE Button	1-5, 1-23
Maintenance	6-8	RECEIVER VOLUME Selector	1-3
Memo message	2-13	Setting	1-14
Recording	2-13	Receiving Tray	1-2, 1-8
Memory playback	4-16	Installing	1-10
MEMO/2WAY REC Button	1-6, 2-10, 2-13, 2-14	Reception	
MESSAGE ALERT	1-25	Automatic	2-7
Setting	4-23	Interrupting	2-6
MIC (Microphone)	1-16	Manual	2-6
Microcassette compartment	1-3	Recording paper	1-8
Cleaning	6-8	Clearing jam of	6-6
Microcassette tape	1-8	Installing	1-12, 1-13
Installing	1-11	RECORDING TIME FOR ANS	1-24
Taking off	1-11	Changing	1-32
MONITOR Button and Indicator	1-5	REDIAL Button	1-5
N		Redialing	2-16
Network Communication	4-5	REMOTE ANS ID	1-24, 4-15, 4-16, 4-19, 4-20
NEW MESSAGES Button	1-6, 2-10, 2-11	Setting the code for	1-33
O		Remote control functions	4-15
One touch dialing	3-3	Back space and skip forward	4-17
Storing phone numbers for	3-3	Playing back all messages	4-16
P		Playing back newly recorded messages	4-16
PAPER OUT Indicator	1-5, 1-15	Recording a marker message	4-17
Paper roll holders	1-8, 1-13	Re-recording a greeting message	4-20
Paper rollers	6-9	Resetting tape for future messages	4-18
PAUSE Button	1-5, 4-26	Room monitor	4-19
Pinch roller	6-8	Skipping the greeting message	4-19
Polling	4-2	REMOTE FAX ACTIVATION CODE	1-25
Polling another unit	4-2, 4-3	Programming	4-11
POLLING Button and Indicator	1-5, 4-2, 4-3	Resetting system parameters	4-30
POLLING PASSWORD	1-25	Resetting tape	4-18
Setting	4-4	RESOLUTION	2-3
POWER Switch	1-3	Setting	2-3
Turning on	1-15	RESOLUTION Button	1-5
PRINT ADVANCED FEATURE LIST	1-24	REW (Rewind) Button	1-6, 2-10, 2-11
PRINT TRANSMISSION REPORT	1-24	RINGER Volume Selector	1-3
Changing	1-28	Setting	1-14
Sample of	1-27	Room monitor	4-19
PRINT JOURNAL	1-25	Rotary pulse dial service (PULSE)	1-14
PRINT TEL LIST	1-25	RX PASSCODE CHECK	1-25, 4-5, 4-6
PRINTER TEST	1-25	Turning on	4-9
Printing	6-10	S	
Printing a test pattern	6-10	SECRET Key	3-2, 3-5
Privacy Ring	4-21	Secret Phone Numbers	3-5
Calling with	4-21	Storing	3-5
PRIVACY RING ID	1-25, 4-21, 4-22	SET Button	1-5, 1-26, 3-2
Programming	4-22	SET DATE	1-24
PROGRAM Button and Indicator	1-5, 1-26, 3-2	SET DEFAULT	1-25
R		Setting date and time	1-18, 1-19
REC Button	1-6, 1-16, 1-17, 2-10	SILENT FAX RECOGNITION RING	1-25
RECEIVE MODE	1-23, 2-7	Setting	4-29
ANS/FAX mode	1-23, 2-7	Skip forward	4-17
		Skipping the greeting message for incoming message recording mode	4-19
		Specifications	6-11

Speed dialing	
Station numbers for	3-2
Storing phone numbers for	3-4
START Button and Indicator	1-6, 1-26
STOP Button	1-6, 1-16, 2-10
STOP/CLEAR Button	1-6, 1-26, 2-5, 3-2

T

TEL mode	1-23
TEL/FAX mode	1-23
Receiving a document in	2-8
Telephone conversation	2-14
Recording	2-14
Telephone line cord	1-8
TELEPHONE NUMBER LIST	5-5
Printing	5-6
Temporary Tone dialing	4-25
Test pattern	6-10
Thermal head	6-9
Cleaning	6-9
TO HANDSET	1-9
Connect to	1-9
Toll Saver	1-29, 1-30
TONE Button	1-5, 4-25
Touch tone service (TONE)	1-14
Transmission	
Interrupting	2-5
Manual	2-4
Using Automatic Dialer	3-7
Troubleshooting	6-2
TX PASSCODE CHECK	1-25, 4-5, 4-6
Turning on	4-8

V

Voice Contact	4-24
Initiating	4-24
Receiving a request for	4-24
VOLUME Control	1-3, 1-16
VOX	1-16, 1-32

Y

YOUR LOGO	1-24
Setting	1-20, 1-21
YOUR TELEPHONE NUMBER	1-24
Programming	1-22

# Button	1-26
* Button	4-25

FAX CORRESPONDENCE

TO: _____ DATE: _____

FROM: _____ OUR TEL. NO.: _____

We would like to take this opportunity to introduce you to our Panasonic telephone answering device with facsimile. Our unit will work as a facsimile, an answering device and a standard telephone, so you can send both documents and voice-messages on the same call.

Transmitting a voice-message and a document

1. Dial our phone number. Our unit will play the greeting message.
2. Leave your message after the long beep.
3. Press “*” (asterisk) button of your phone after recording your incoming message.
Our unit will switch to the facsimile mode and a fax tone sounds.
4. Start transmission to send a fax after hearing the fax tone.

Transmitting a document only

1. Dial our phone number. Our unit will play the greeting message.
2. Start transmission to send a fax while the greeting message is being played.
 - You may press “*” (asterisk) button while the greeting message is being played. Start transmission after hearing the fax tone.

If you call from a rotary (pulse) phone:

Transmitting a document only

1. Dial our phone number.
Our unit will play the greeting message.
2. Start transmission to send a fax while the greeting message is being played.

Transmitting a document and a voice-message

1. Dial our phone number.
Our unit will play the greeting message.
2. Start transmission to send a fax.
3. Make a call reservation (e.g. ...lift the handset) during transmission of your document.
4. Leave your message after the long beep following the greeting message.

NOTE:

If our unit is in a fax mode, the greeting message is not played and a fax tone sounds. You cannot talk to us, and fax reception is only available.

SPEED DIALER LIST

CODE	NAME
0	
1	
2	
3	
4	
5	
6	
7	
8	
9	

Transmitting a document using speed dialing:

Insert the documents FACE DOWN, then press the AUTO button and the code number (0 through 9).

OPERATION FROM TONE PHONE

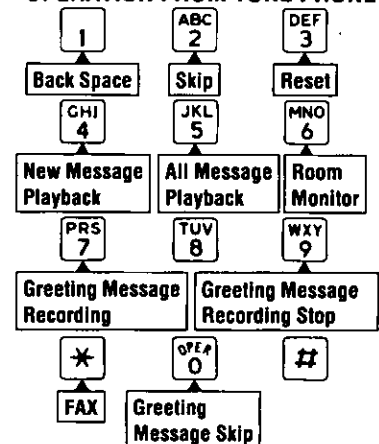

- To set the ANS/FAX mode, call your unit and wait for 15 rings. The unit will answer, then hang up.
- To send the document, press **■**. The "beep" (fax tone) is heard. Then start transmission.

SPEED DIALER LIST

CODE	NAME
0	
1	
2	
3	
4	
5	
6	
7	
8	
9	

Transmitting a document using speed dialing:

Insert the documents FACE DOWN, then press the AUTO button and the code number (0 through 9).

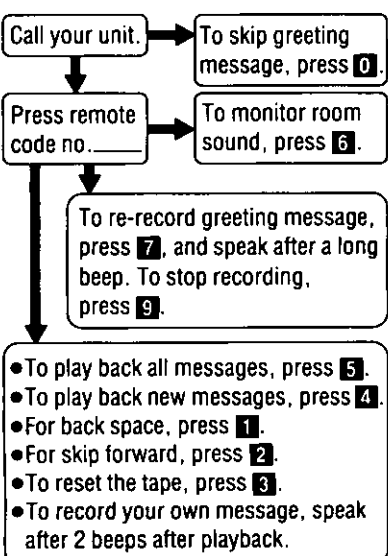

When you press a button, press firmly.

Servicenter Directory

**PRODUCT INFORMATION • OPERATION ASSISTANCE • LITERATURE
REQUESTS • DEALER LOCATIONS**

DIAL TOLL FREE: 1-800-HELP-FAX

Customer Service Center 2F-3, One Panasonic Way, Secaucus, NJ 07094 (Headquarters)
201-348-9090 (9:00am–8:00pm Monday–Friday, EST)

SERVICE INQUIRIES

Regional Customer Care Department

NORTHEAST

2221 Cabot Boulevard West
Suite A
Langhorne, PA 19047
215-741-0676

Covers:

CT, DE, ME, MD, MA,
NH, NJ, NY, PA, RI, VT,
VA, DC, WV, Eastern OH

MIDWEST

1703 North Randall Road
Elgin, IL 60123
708-468-5530

Covers:

IL, IN, IA, KS, KY, MI,
MN, MO, NE, ND, SD,
WI, Western OH

WESTERN

6550 Katella Avenue
Cypress, CA 90630
714-373-7440

Covers:

AK, AZ, CA, CO, ID,
MT, NV, NM, OR, UT,
WA, WY, HI

SOUTHERN

1854 Shackelford Court
Suite 4105
Norcross, GA 30093
404-717-6860

Covers:

AL, AR, FL, GA, LA,
MS, NC, OK, SC, TN, TX

PRODUCT SERVICE

Factory Servicenters

CALIFORNIA

6550 Katella Avenue
Cypress, CA 90630
714-373-7425

+930 South Mt. Vernon
Avenue
Suite 200
Colton, CA 92324
714-825-3110

800 Dubuque Avenue
So. San Francisco,
CA 94080
415-871-6373

20201 Sherman Way
Suite 102
Canoga Park, CA 91306
818-709-1775

+3878 Ruffin Road
Suite A
San Diego, CA 92123
619-560-9200

COLORADO

1640 South Abilene Suite D
Aurora, CO 80012
303-752-2024

FLORIDA

3700 North 29th Avenue
Suite 102
Hollywood, FL 33020
305-925-2880

+pick-up/drop-off only

4115 W. Kennedy Boulevard
Tampa, FL 33609
813-289-9726

GEORGIA

4245 International Boulevard
Suite C
Norcross, GA 30093
404-717-6880

HAWAII

99-859 Iwaiwa Street
Aiea, Hawaii 96701
808-488-1996

ILLINOIS

1703 North Randall Road
Elgin, IL 60123
708-468-5454

9401 W. Grand Avenue
Franklin Park, IL 60131
708-452-2580

MARYLAND

Sulphur Springs
Business Center
1638 Sulphur Springs Road
Baltimore, MD 21227
410-242-2607

MASSACHUSETTS

383 University Avenue
Westwood, MA 02090
617-329-4280

MICHIGAN

37048 Van Dyke Avenue
Sterling Heights, MI 48312
313-939-2060

MINNESOTA

7850-12th Avenue South
Airport Business Center
Bloomington, MN 55425
612-854-8624

MISSOURI

11982 Dorsett Road
Maryland Heights, MO 63043
314-739-5301

OHIO

1196 W. Kemper Road
Cincinnati, OH 45240
513-851-4180

PENNSYLVANIA

2221 Cabot Boulevard West
Suite B
Langhorne, PA 19047
215-741-0661
Campbell's Run
Business Center
500 Business Center Drive
Pittsburgh, PA 15205
412-788-2174

TENNESSEE

919-8th Avenue South
Nashville, TN 37203
615-244-4434

TEXAS

7420 Harwin Drive
Houston, TX 77036
713-781-1528
4500 Amon Carter Boulevard
Fort Worth, TX 76155
817-685-1060

WASHINGTON

20425-84th Avenue South
Kent, WA 98032
206-872-7922

Service in Puerto Rico

**Matsushita Electric
of Puerto Rico, Inc.
Panasonic Sales Company/
Factory Servicenter**

San Gabriel Industrial Park
65th Infantry Avenue KM 9.5
Carolina, Puerto Rico 00630
809-750-5135

AUTHORIZED SERVICENTERS • PARTS DISTRIBUTOR LOCATIONS

To locate an independent authorized servicenter or parts distributor in your area, within the USA dial toll free
1-800-545-2672, 24 hours a day, 7 days a week.

ACCESSORY PURCHASES

1-800-332-5368 (Consumer Orders Only)

Matsushita Services Company Box 01, 545 Tollgate Road Suite C, Elgin, IL 60123

(8:00am–7:30pm Monday–Thursday; 8:00am–5:00pm Friday; 9:00am–12:30pm Saturday; CST)

(Visa, Mastercard, Discover card, Check or Money Order)

(930323)

PANASONIC ANSWERING SYSTEM WITH FACSIMILE

Limited Warranty

Panasonic Company, Panasonic Company (West) of America or Panasonic Sales Company (collectively referred to as "PANASONIC"), will repair this product with new or rebuilt parts, free of charge, in the U.S.A. or Puerto Rico for one (1) year from the date of original purchase in the event of a defect in materials or workmanship.

Batteries (when applicable)—New rechargeable batteries in exchange for defective rechargeable batteries for ten (10) days from the date of original purchase. Non-rechargeable batteries are not warranted.

Carry-in or mail-in service in the U.S.A. can be obtained during the warranty period from a Matsushita Services Company (MSC) Factory Servicenter listed in the Servicenter Directory. Carry-in or mail-in service in Puerto Rico can be obtained during the warranty period by calling the telephone numbers listed in the Servicenter Directory.

This warranty is extended only to the original purchaser. A purchase receipt or other proof of date of original purchase will be required before warranty performance is rendered.

This warranty only covers failures due to defects in materials or workmanship which occur during normal use. It does not cover damage which occurs in shipment or failures which are caused by products not supplied by PANASONIC or failures which result from accident, misuse, abuse, neglect, mishandling, misapplication, alteration, faulty installation, modification, or service by anyone other than a MSC Factory Servicenter or an authorized MSC Servicenter or damage that is attributable to Acts of God, including, but not limited to, line surges.

LIMITS AND EXCLUSIONS

There are no express warranties except as listed above.

PANASONIC SHALL NOT BE LIABLE FOR SPECIAL, INCIDENTAL, CONSEQUENTIAL OR PUNITIVE DAMAGES, INCLUDING, WITHOUT LIMITATION, LOSS OF GOODWILL, PROFITS OR REVENUE, LOSS OF USE OF THIS PRODUCT OR ANY ASSOCIATED EQUIPMENT, COST OF SUBSTITUTE EQUIPMENT, DOWNTIME COSTS, OR CLAIMS OF ANY PARTY DEALING WITH BUYER FOR SUCH DAMAGES, RESULTING FROM THE USE OF THIS PRODUCT OR ARISING FROM BREACH OF WARRANTY OR CONTRACT, NEGLIGENCE, OR ANY OTHER LEGAL THEORY.

ALL EXPRESS AND IMPLIED WARRANTIES, INCLUDING THE WARRANTIES OF MERCHANTABILITY AND FITNESS FOR A PARTICULAR PURPOSE, ARE LIMITED TO THE APPLICABLE WARRANTY PERIOD SET FORTH ABOVE.

Some states do not allow the exclusion or limitation of consequential damages, or limitations on how long an implied warranty lasts, so the above exclusions or limitations may not apply to you.

This warranty gives you specific legal rights, and you may also have other rights which vary from state to state.

If a problem with this ANSWERING SYSTEM WITH FACSIMILE develops during the warranty period, you may contact your dealer or the MSC Factory Servicenter or authorized Panasonic Service Dealer. If the problem is not handled to your satisfaction, write to the Panasonic Company Consumer Affairs Division at the address indicated on the Servicenter Directory.

**Panasonic Company,
Division of Matsushita Electric Corporation of America**
One Panasonic Way, Secaucus, New Jersey 07094

**Panasonic Company (West) of America,
Division of Matsushita Electric Corporation of America**
6550 Katella Avenue, Cypress, California 90630

**Panasonic Sales Company ("PSC"),
Division of Matsushita Electric of Puerto Rico, Inc.**
San Gabriel Industrial Park, 65th Infantry Avenue, KM 9.5, Carolina, Puerto Rico 00630